

# YOUSHI®

通过ISO13485质量管理体系认证  
通过欧盟CE认证  
获得美国FDA注册

# YOUSHI®

桐庐优视医疗器械有限公司  
TONG LU YOUSHI MEDICAL INSTRUMENT CO., LTD  
杭州优美医疗设备有限公司  
HANGZHOU YOUMEI MEDICAL EQUIPMENT CO., LTD

内窥镜系列手术器械  
ENDOSCOPIA MEDICAL INSTRUMENT



桐庐优视医疗器械有限公司  
TONG LU YOUSHI MEDICAL INSTRUMENT CO., LTD  
杭州优美医疗设备有限公司  
HANGZHOU YOUMEI MEDICAL EQUIPMENT CO., LTD

地址:浙江省桐庐县县城尖端路112号 邮编 (P.C.): 311500  
ADD: No. 112 Jianduan Road, Tonglu, Zhejiang, China 311500  
电话 (TEL): 86-571-64278885 64278886 (国内销售部)  
86-571-64286222 (Export department)  
传真 (FAX): 86-571-64278886  
Http://www.china-youshi.com  
E-mail:youshi@china-youshi.com (办公室)  
E-mail:sales@china-youshi.com (国内销售部)  
E-mail:export@china-youshi.com (Export department)  
E-mail:export-1@china-youshi.com (Export department)

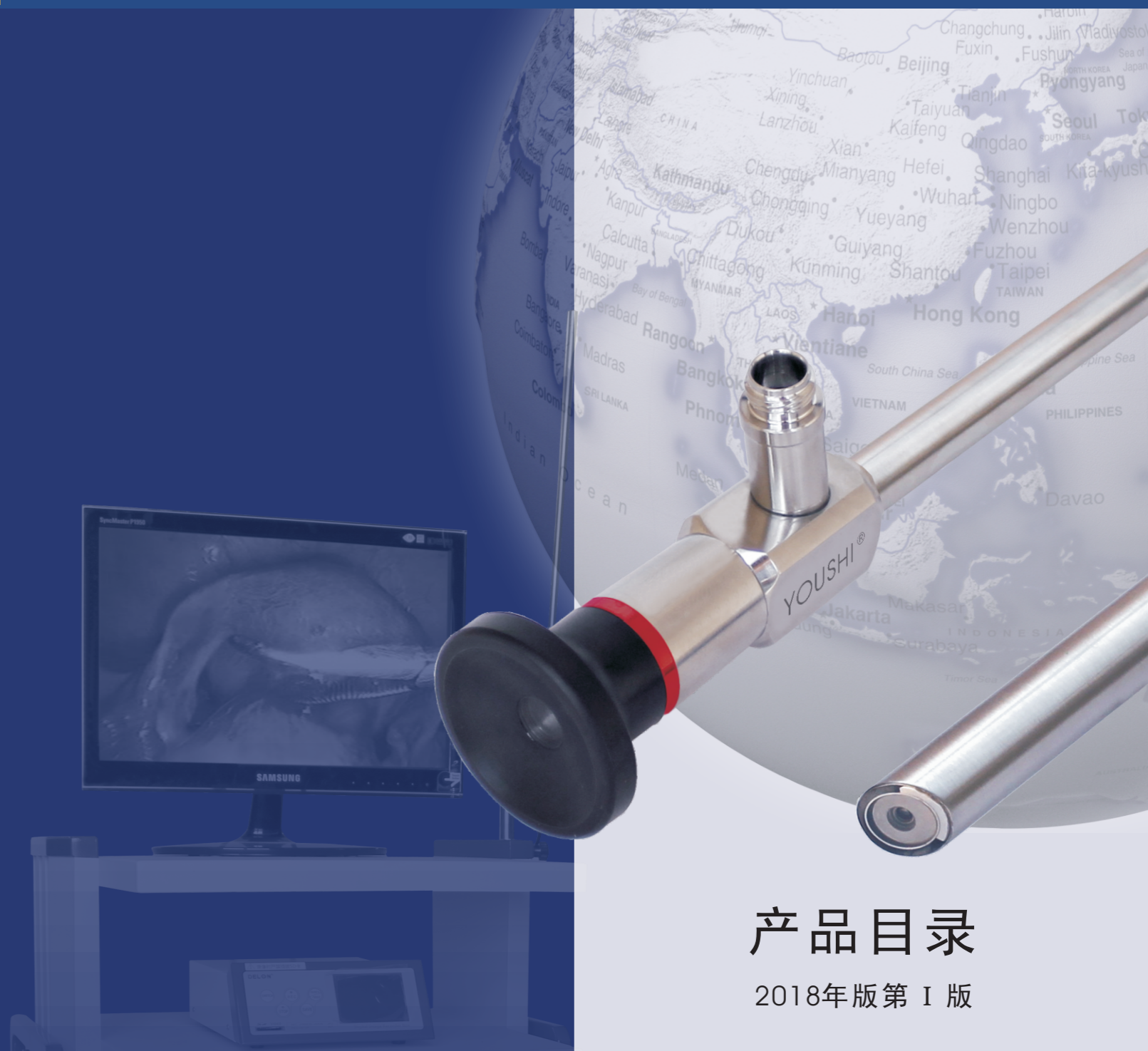

产品目录  
2018年版第 I 版

## 公司简介 Introduction

医之优品，健康视界。

桐庐---富春江畔的一颗璀璨明珠！

桐庐---中国微创外科手术器械的发祥地！

优视---中国医疗器械微创领域的耀眼之星！

公司坚持高起点的科技发展之路，汇聚了中国医疗器械行业设计开发、生产、销售、管理等各级精英，通过了EN ISO9001、EN ISO13485国际质量管理体系、欧盟CE认证和美国FDA注册，是国家重点扶持的高新技术企业。

公司生产的产品涉及腹部外科、胸外科、妇科、泌尿外科、耳鼻喉科、骨科等领域，在临床应用中得到了广大医护人员的肯定与青睐！

优视---致力于开发拥有自主知识产权的产品，杜绝仿冒和粗制滥造，不断自主创新与精工设计！

优视---致力于品牌和市场同发展，以质量创立品牌，以品牌立足市场，创“优视”产品为优势产品！

优视---愿与各位同仁携手共进，致力于医疗器械“中国制造”！

YOUSHI, a superior company.

Tonglu---A bright pearl in the southern city

Tonglu---The cradle of the modern minimal invasive surgery instruments

YOUSHI---A bright star in Chinese minimal invasive surgery instruments industry

Keeping on developing with high technology, Youshi has many experts in design, R&D, manufacture, sales, management, has gotten EN ISO9001, EN ISO13485, CE and FDA registration. Youshi is the national priority support of high-tech enterprises

Youshi products are popular with the hospitals, our products includes abdominal surgery, thoracoscopy, gynaecology, urology, ENT, orthopedics and so on.

YOUSHI---engaged in developing products with independent intellectual property rights, keeping on innovation and design, resisting rough quality

YOUSHI---engaged in developing market with brand, creating brand with quality, occupying market with brand, developing Youshi product into dominant product

YOUSHI---Longing for cooperate with other companies to make effort in the “Made in China” medical instruments



厂区一角

## 目录 List

### 胸腹腔镜手术器械 Laparoscope Instruments

Ys101 腹腔镜手术器械 Laparoscope instruments	Page 3-15
YS104 甲状腺手术器械 Thyroid Instruments	Page 15
YS113 可旋转可弯曲手术器械 Instrumens	Page 16
YS112 单孔（经脐部）腹腔镜手术器械 Single port instruments	Page 17
YS115 XW型胸腔镜外科手术器械 Thoracoscopy instruments	Page 18-20
一次性使用医疗手术器械 Disposable instruments II	Page 21

### 妇科医疗手术器械 Gynaecology

YS201 DZ型电动子宫切除器及配套手术器械 Electric uterus-cutter and accessories	Page 22-23
YS202 GQJ-II型、YS203A GQJ-I型、YS203B GQJ-III型宫腔内窥镜 Hysteroscopy set	Page 24-25
YS207 DC型多功能子宫操纵器 Multi-functional uterus apparatus	Page 26-27
YS206 JGQ型举宫器 Uterus apparatus	Page 27
YS211 DQJ-I型电切镜（宫腔） Hystero resectoscope	Page 28
YS209A ZZ型阴式子宫诊疗成套手术器械 Instruments for Hysterectomy surgery	Page 29
YS209B ZZ型阴式子宫诊疗成套手术器械（专用阴道拉钩） Instruments for Hysterectomy surgery	Page 29-30
YS209C ZZ型阴式子宫诊疗成套手术器械（专用阴道缝合拉钩） Instruments for Hysterectomy surgery	Page 30

### 泌尿外科手术器械 Urological Department 肛肠科手术器械 Intestine Instruments

Ys501 膀胱碎石镜 Lithotripsy scope	Page 31
YS508 输尿管肾镜 Ureterorenoscopy set	Page 31
YS503 NPJ-I型尿道膀胱镜（锁口式） Cystoscope (Lockable)	Page 32
YS504 DQJ-I型电切镜 Vaporization resectoscope	Page 33
YS507 尿道切开器（锁口式） Urethrotomy set (Lockable)	Page 34

### 耳鼻喉科手术器械 E.N.T Department

Ys305 ERK型耳科手术器械包 Ear Surgical instruments set	Page 35
YS308 耳用刨削器（耳电钻） Otoscope cutting aspirator	Page 35
YS306 鼻窦刨削器（鼻电钻） Uptodate oesophagoscope	Page 36
YS401 食道镜 Esophagoscope	Page 36
YS301 BD型鼻窦镜、鼻窦镜成套手术器械 Sinoscope set	Page 37-38
YS303 ZC型支撑喉镜 Self-retaining laryngoscopy set	Page 39

### 骨科手术器械 Orthopaedics

YS601 关节镜手术器械 Arthroscopy set	Page 40
YS602 关节刨削器 Arthroscope electric-drill	Page 40

### 医疗设备 Accessories

内窥镜影像系统 Endoscope display system	Page 41
医用内窥镜冷光源 Cold light source	Page 41
医用内窥镜摄像系统 CCD Camera	Page 41
光学接口 Optics-port	Page 41
导光束 Light guide cable	Page 41
内窥镜连接器 Adaptor for endoscope	Page 41
医用加压器（蠕动泵） Suction Irrigation appliance	Page 41
医用加压器（冲吸泵） Suction Irrigation appliance	Page 42
气腹机 Insufflator	Page 42
高频电刀 High frequency electric-cutter	Page 42
模拟操作箱 Analog operation box	Page 42
器械清洗泵 Suction & rinsing apparatus	Page 42
医用器械灭菌盒 Sterilization case	Page 42
医用内窥镜灭菌盒 Sterilization case	Page 42

### FQJ- I 型腹腔镜 Laparoscope

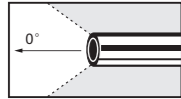

FQJ- I 型腹腔镜 Laparoscope  
Y1010 0°  $\phi$ 10mm X 320mm  
Y1010.5 0°  $\phi$ 5mm X 300mm

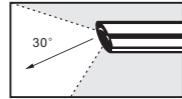

FQJ- I 型腹腔镜 Laparoscope  
Y1013 30°  $\phi$ 10mm X 320mm  
Y1013.5 30°  $\phi$ 5mm X 300mm



内窥镜摄像系统示意图  
Endoscope system

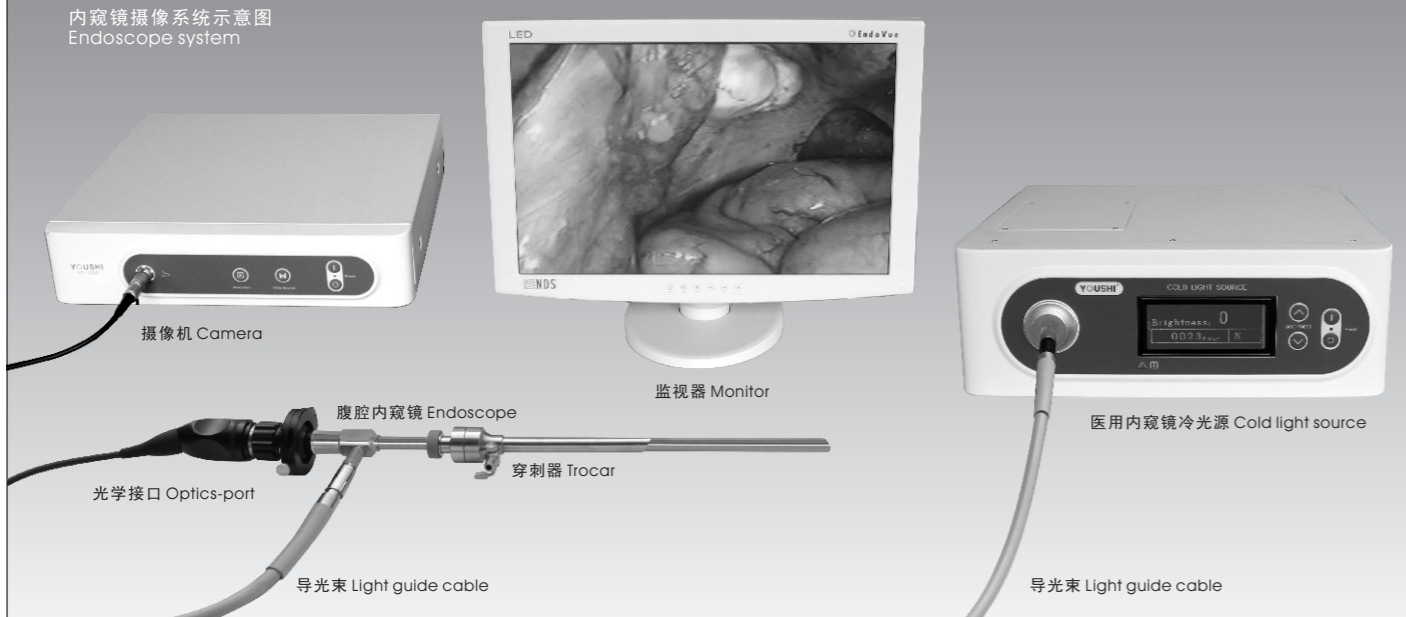



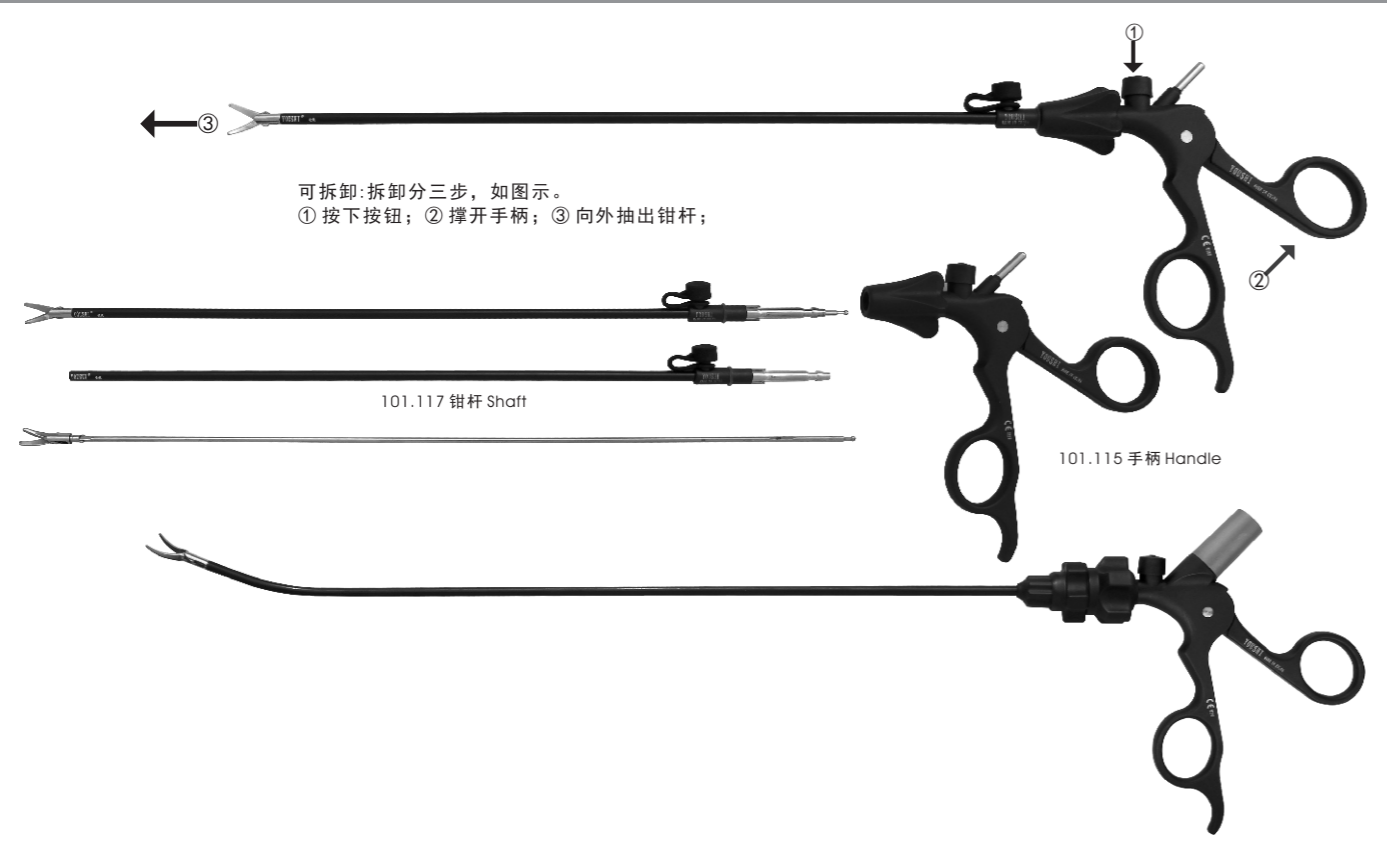







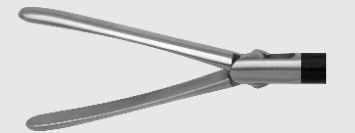
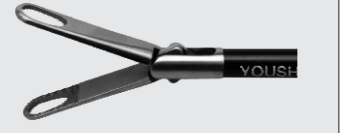

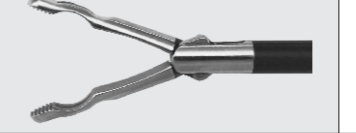

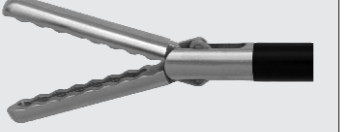
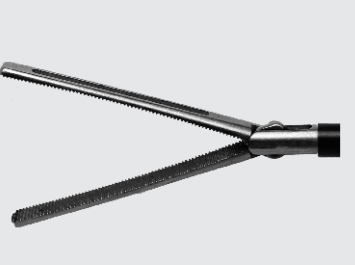
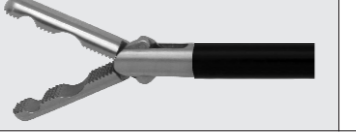
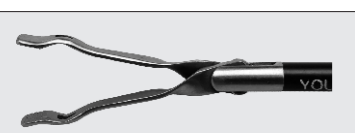
### 手术钳、手术剪刀 Forceps and Scissors

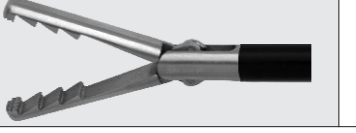

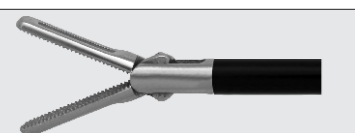

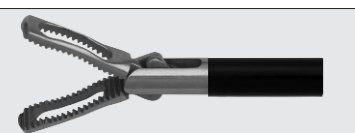
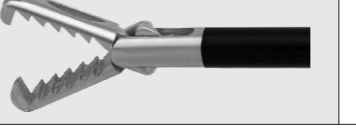

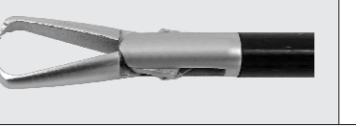
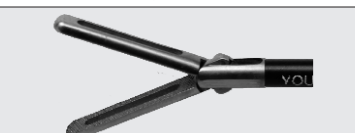

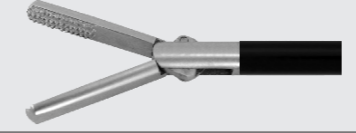
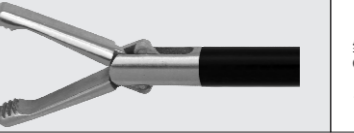
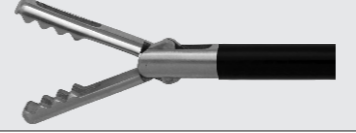
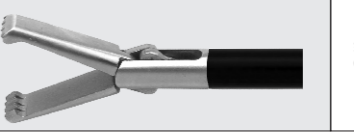
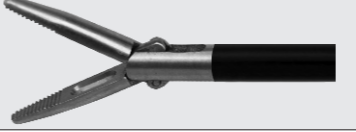
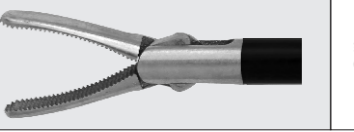

### 手术钳、手术剪刀 Forceps and Scissors

	直剪 (单动) Straight-Scissors 101.020 $\phi$ 10 X 330mm 101.021 $\phi$ 5 X 330mm 102.012 $\phi$ 3 X 300mm 103.003 $\phi$ 5 X 210mm		弯分离钳 (短头网齿) Maryland forceps (Curved) 101.028C $\phi$ 5 X 330mm
	弯剪 Curved-Scissors 101.022.1 $\phi$ 5 X 330mm 102.013.1 $\phi$ 3 X 300mm 103.004.1 $\phi$ 5 X 210mm		弯分离钳 (特特弯) Maryland forceps (Curved) 101.028D $\phi$ 5 X 330mm
	直剪 (微型) Tiny-Scissors 101.023 $\phi$ 5 X 330mm		弯分离钳 (偏直) Maryland forceps (Curved) 101.028E $\phi$ 5 X 330mm
	直剪 (双动) Straight-Scissors 101.020.1 $\phi$ 10 X 330mm 101.021.1 $\phi$ 5 X 330mm 102.012.1 $\phi$ 3 X 300mm 103.003.1 $\phi$ 5 X 210mm		弯分离钳 maryland forceps 101.028F $\phi$ 5 X 330mm
	弯剪 Curved-Scissors 101.022 $\phi$ 5 X 330mm 102.013 $\phi$ 3 X 300mm 103.004 $\phi$ 5 X 210mm		弯分离钳 maryland forceps 101.028G $\phi$ 5 X 330mm
	直剪 (钩型) Hook-Scissors 101.024 $\phi$ 5 X 330mm 102.014 $\phi$ 3 X 300mm 103.005 $\phi$ 5 X 210mm		弯分离钳 (70°) Dissecting forceps (70° curved) 101.029 $\phi$ 5 X 330mm
	直分离钳 Dissecting forceps (Straight) 101.027 $\phi$ 5 X 330mm 102.015 $\phi$ 3 X 300mm 103.006 $\phi$ 5 X 210mm		弯分离钳 (70°) Dissecting forceps(70°) 101.029.3 $\phi$ 5 X 330mm
	直分离钳 Dissecting forceps(Straight) 101.027.5 $\phi$ 5 X 330mm		弯分离钳 (70°) Dissecting forceps(70°) 101.029.4 $\phi$ 5 X 330mm
	弯分离钳 Maryland forceps (Curved) 101.025 $\phi$ 10 X 330mm 101.028 $\phi$ 5 X 330mm 102.016 $\phi$ 3 X 300mm 103.007 $\phi$ 5 X 210mm		弯分离钳 (90°) Dissecting forceps (90°) 101.026 $\phi$ 10 X 330mm 101.030 $\phi$ 5 X 330mm 102.017 $\phi$ 3 X 300mm 103.008 $\phi$ 5 X 210mm
	弯分离钳 (钝头) Maryland forceps (Curved) 101.028A $\phi$ 5 X 330mm		弯分离钳 (90°) Dissecting forceps(90°) 101.030.3 $\phi$ 5 X 330mm
	弯分离钳 (钝头) maryland forceps(Curved) 101.028A.1 $\phi$ 5 X 330mm		长颌抓钳 Large-jaw grasping forceps 101.036 $\phi$ 5 X 330mm 105.007 $\phi$ 10 X 330mm
	弯分离钳 (网齿) Maryland forceps (Curved) 101.028B $\phi$ 5 X 330mm		长颌抓钳 (中空) Large-jaw grasping forceps (Fenestrated) 101.037 $\phi$ 5 X 330mm 106.004 $\phi$ 10 X 330mm

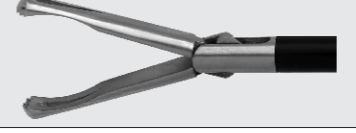
手术钳、手术剪刀 Forceps and Scissors

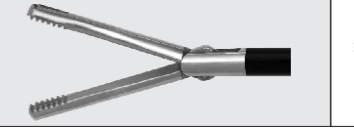
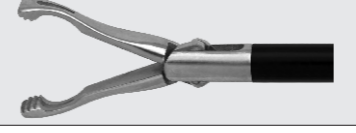
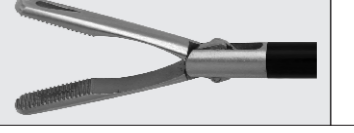
	长颌抓钳 (无齿) Large-jaw grasping forceps (Toothless) 101.038 $\Phi$ 5 X 330mm		无损伤抓钳 Atraumatic forceps 101.041.9 $\Phi$ 5 X 330mm
	长颌抓钳 (O型中空) Large-jaw grasping forceps (Toothless) 101.038.1 $\Phi$ 5 X 330mm		无损伤抓钳 (小抓钳) Atraumatic forceps 101.041.2 $\Phi$ 5 X 330mm
	长颌抓钳 (板克) Large-jaw grasping forceps (Toothless) 101.038.2 $\Phi$ 5 X 330mm		无损伤抓钳 (粗齿) Atraumatic forceps (Rough tooth) 101.042 $\Phi$ 5 X 330mm
	长颌抓钳 (O型中空) Large-jaw grasping forceps (Fenestrated) 101.038.3 $\Phi$ 5 X 330mm		组织抓取钳 (重型) Maxi forceps 101.043 $\Phi$ 5 X 330mm 102.004 $\Phi$ 3 X 300mm 103.010 $\Phi$ 5 X 210mm
	长颌抓钳 (板克) Large-jaw grasping forceps (Toothless) 101.038.4 $\Phi$ 5 X 330mm		组织抓取钳 (倒齿) Pwl grasping forceps 101.044 $\Phi$ 5 X 330mm 102.005 $\Phi$ 3 X 300mm 103.011 $\Phi$ 5 X 210mm
	鸭嘴抓钳 Duck-mouth grasping forceps 101.039 $\Phi$ 5 X 330mm 102.003 $\Phi$ 3 X 300mm 105.008 $\Phi$ 10 X 330mm		组织抓取钳 (倒齿加长) Pwl grasping forceps (Lengthen) 101.045 $\Phi$ 5 X 330mm
	组织抓取钳 (无创) Atraumatic forceps 101.040 $\Phi$ 5 X 330mm 102.009 $\Phi$ 3 X 300mm		组织抓取钳 (鼠牙) Set forceps (2+3齿 Tooth 双动) 101.047 $\Phi$ 5 X 330mm
	无损伤抓钳 Atraumatic forceps 101.041 $\Phi$ 5 X 330mm 102.008 $\Phi$ 3 X 300mm		组织抓取钳 (鼠牙) Set forceps (1+2齿 Tooth 单动) 101.047.1 $\Phi$ 5 X 330mm
	无损伤抓钳 Atraumatic forceps 101.041.1 $\Phi$ 5 X 330mm		组织抓取钳 (鼠牙) Set forceps (2+3齿 Tooth 双动) 101.048 $\Phi$ 5 X 330mm
	无损伤抓钳 Atraumatic forceps 101.041.7 $\Phi$ 5 X 330mm		组织抓取钳 (鼠牙) Set forceps (1+2齿 Tooth 短 Short) 101.049 $\Phi$ 5 X 330mm
	钝头抓钳 Blunt grasping forceps 101.050 $\Phi$ 5 X 330mm 102.010 $\Phi$ 3 X 300mm		钝头抓钳 (粗齿) Blunt grasping forceps (Rough tooth) 101.051 $\Phi$ 5 X 330mm

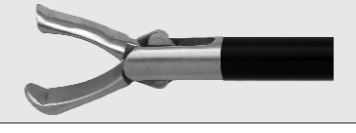
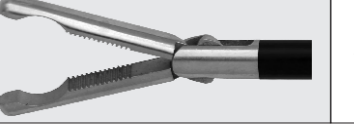
手术钳、手术剪刀 Forceps and Scissors

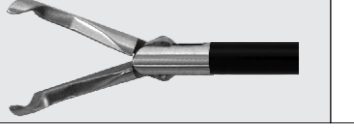
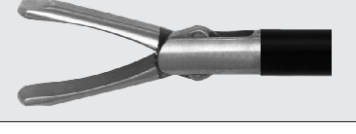
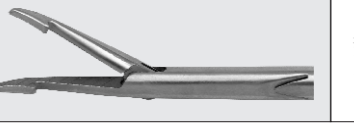
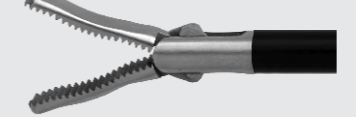
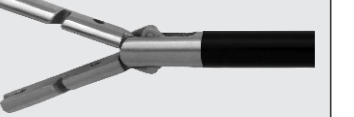
	组织抓取钳 (细齿) Grasping forceps (Greeve) 101.052 $\Phi$ 5 X 330mm		组织抓取钳 (中空横齿) Grasping forceps (Central hollow, contrate) 101.063 $\Phi$ 5 X 330mm
	无损伤抓钳 (粗齿/中空) Grasping forceps (Rough tooth, Fenestrated) 101.053 $\Phi$ 5 X 330mm		组织抓取钳 (中空竖齿) Grasping forceps (Fenestrated, vertical) 101.064 $\Phi$ 5 X 330mm
	组织抓取钳 (尖头) Tine forceps 101.054 $\Phi$ 5 X 330mm 102.006 $\Phi$ 3 X 300mm		组织抓取钳 (O型) O-Grasping forceps 101.065 $\Phi$ 5 X 330mm
	活检钳 Small Biopsy forceps 101.056 $\Phi$ 5 X 330mm		组织抓取钳 (O型/中空) O-Grasping forceps (Fenestrated) 101.066 $\Phi$ 5 X 330mm
	组织抓取钳 (阑尾) Appendiceal forceps 101.057 $\Phi$ 5 X 330mm		无损伤抓钳 (齿粗/三孔) Triporate forceps 101.067 $\Phi$ 5 X 330mm
	活检钳 (犬齿) Biopsy forceps (with eyetooth) 101.058 $\Phi$ 5 X 330mm		组织抓取钳 (固定) Stomach grasping forceps 101.046 $\Phi$ 5 X 330mm
	胆囊抓钳 Babcock grasper forceps 101.059 $\Phi$ 5 X 330mm		组织抓取钳 (胃) Stomach grasping forceps 101.071 $\Phi$ 5 X 330mm
	组织抓取钳 (咬切) Biopsy forceps with cutting action 101.060 $\Phi$ 5 X 330mm		组织抓取钳 (肝) Liver grasping forceps 101.073 $\Phi$ 5 X 330mm
	组织抓取钳 (输卵管) Oviduct forceps 101.061 $\Phi$ 5 X 330mm		组织抓取钳 (吻合牵引) Tally pull forceps 101.074 $\Phi$ 5 X 330mm
	组织抓取钳 (输卵管) Oviduct forceps 101.061.2 $\Phi$ 5 X 330mm		组织抓取钳 (吻合) Tally pull forceps 101.074.1 $\Phi$ 5 X 330mm
	组织抓取钳 (输尿管) Oviduct forceps 101.061.1 $\Phi$ 5 X 330mm		打结钳 (A型) A-knot forceps 101.077 $\Phi$ 5 X 330mm 102.011 $\Phi$ 3 X 300mm
	组织抓取钳 (系膜) Mesentery forceps 101.062 $\Phi$ 5 X 330mm		打结钳 (B型) B-knot forceps 101.078 $\Phi$ 5 X 330mm

手术钳、手术剪刀 Forceps and Scissors

	组织抓取钳 (小抓钳) Grasping forceps 101.098 $\phi 5 \times 330\text{mm}$		组织抓取钳 (单动/二孔) Croce-olmi 101.099 $\phi 5 \times 330\text{mm}$
	组织抓取钳 (单动/二孔) Croce-olmi 101.099.3 $\phi 5 \times 330\text{mm}$		组织抓取钳 (单孔) Grasping forceps 101.105 $\phi 5 \times 330\text{mm}$
	组织抓取钳 (Allis) Grasping forceps (Allis) 101.106 $\phi 5 \times 330\text{mm}$		肺叶钳 Lung lobe forceps 105.004.3 $\phi 5 \times 330\text{mm}$

手术钳、手术剪刀 Forceps and Scissors

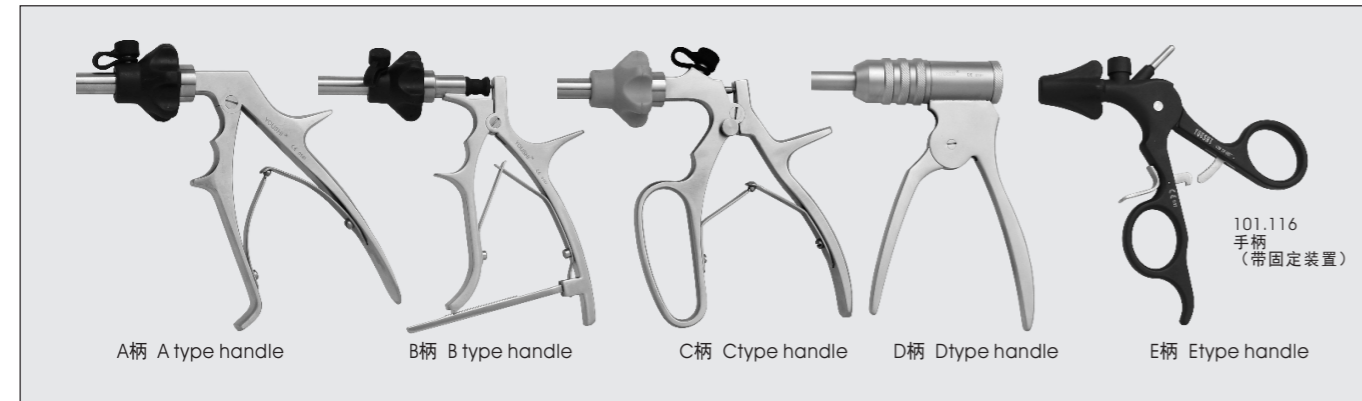

	钛夹钳 (单动) Clip applicator (Single action) 101.001 $\phi 10 \times 330\text{mm}$		钛夹钳 (双动) Clip applicator (Double action) 101.002 $\phi 10 \times 330\text{mm}$		钛夹钳 (直角) 90° Clip applicator (right angle) 101.003 $\phi 10 \times 330\text{mm}$
	钛夹钳 (单动) Clip applicator (Single action) 101.004 $\phi 5 \times 330\text{mm}$ 201.001 $\phi 5 \times 300\text{mm}$		生物夹钳 Hem-o-lok 配生物夹 With biological clip 101.005 $\phi 10 \times 330\text{mm}$		塑料夹钳 Hem-O-Lok 配黄/紫塑料夹 With plastic clip 101.005.1 $\phi 10 \times 330\text{mm}$ 紫    101.005.2 $\phi 5 \times 330\text{mm}$ 绿 101.005.3 $\phi 10 \times 330\text{mm}$ 黄
	塑料夹钳 Hem-O-Lok 配强生吸收夹 With Johnson clip 101.005.4 $\phi 10 \times 330\text{mm}$		有齿抓钳 (单动) Grasping forceps 101.018 $\phi 10 \times 330\text{mm}$ 102.002 $\phi 2.8 \times 300\text{mm}$		有齿抓钳 (双动) Grasping forceps 101.018.1 $\phi 10 \times 330\text{mm}$
	有齿抓钳 (单齿) Grasping forceps (two teeth) 101.018.2 $\phi 10 \times 330\text{mm}$ (1+1齿)		有齿抓钳 (双动) Grasping forceps (Tooth) 101.018.5 $\phi 10 \times 330\text{mm}$		取石钳 Biopsy forceps 101.019 $\phi 10 \times 330\text{mm}$ 103.002 $\phi 10 \times 210\text{mm}$

手术钳、手术剪刀 Forceps and Scissors

	弯剪 (双动) Curved-Scissors 101.022.2 $\phi 10 \times 330\text{mm}$		弯分离钳 (70°) Dissecting forceps (70° curved) 101.025.1 $\phi 10 \times 330\text{mm}$		弯分离钳 (70°) Dissecting forceps(70°) 101.025.2 $\phi 10 \times 330\text{mm}$
	弯分离钳 (90°弧弯) Dissecting forceps(90°) 101.026.1 $\phi 10 \times 330\text{mm}$		弯分离钳 (90°) Dissecting forceps(90°) 101.026.2 $\phi 10 \times 330\text{mm}$		弯分离钳 (90°) Dissecting forceps(90°) 101.026.3 $\phi 10 \times 330\text{mm}$
	弯分离钳 (90°) Dissecting forceps(90°) 101.026.4 $\phi 10 \times 330\text{mm}$		弯分离钳 (90°) Dissecting forceps(90°) 101.026.5 $\phi 10 \times 330\text{mm}$		胆囊抓钳 Babcock grasping forceps 101.059.1 $\phi 10\text{mm} \times 330\text{mm}$
	组织抓取钳 (胃圆头) Stomach grasping forceps 101.072.1 $\phi 10 \times 330\text{mm}$		阻断抓钳 Grasping forceps 101.079 $\phi 10 \times 330\text{mm}$		组织抓取钳 (板克) Grams clamp plate 101.126 $\phi 10 \times 330\text{mm}$
	组织抓取钳 (吻合) Tally pull forceps 101.138 $\phi 10 \times 330\text{mm}$		肺叶钳 Lung lobe forceps 105.004 $\phi 10 \times 330\text{mm}$		无损抓钳 Atraumatic forceps 105.006 $\phi 10 \times 330\text{mm}$
	长颌抓钳 Grasping forceps (Large-jaw) 105.007 $\phi 10\text{mm} \times 330\text{mm}$		鸭嘴抓钳 Duck-jaw forceps 105.008 $\phi 10\text{mm} \times 330\text{mm}$		无齿抓钳 Broadmouth forceps 106.003 $\phi 10 \times 330\text{mm}$

双极电凝钳 Bipolar Forceps

DN-II 型双极电凝钳 (有分离功能)  
101.017A  $\Phi 5 \times 330\text{mm}$   
101.017B  $\Phi 5 \times 330\text{mm}$   
101.017C  $\Phi 5 \times 420\text{mm}$  可弯曲

可拆卸: 拆卸分三步, 如图示。  
① 按下按钮; ② 撑开手柄; ③ 向外抽出钳杆;

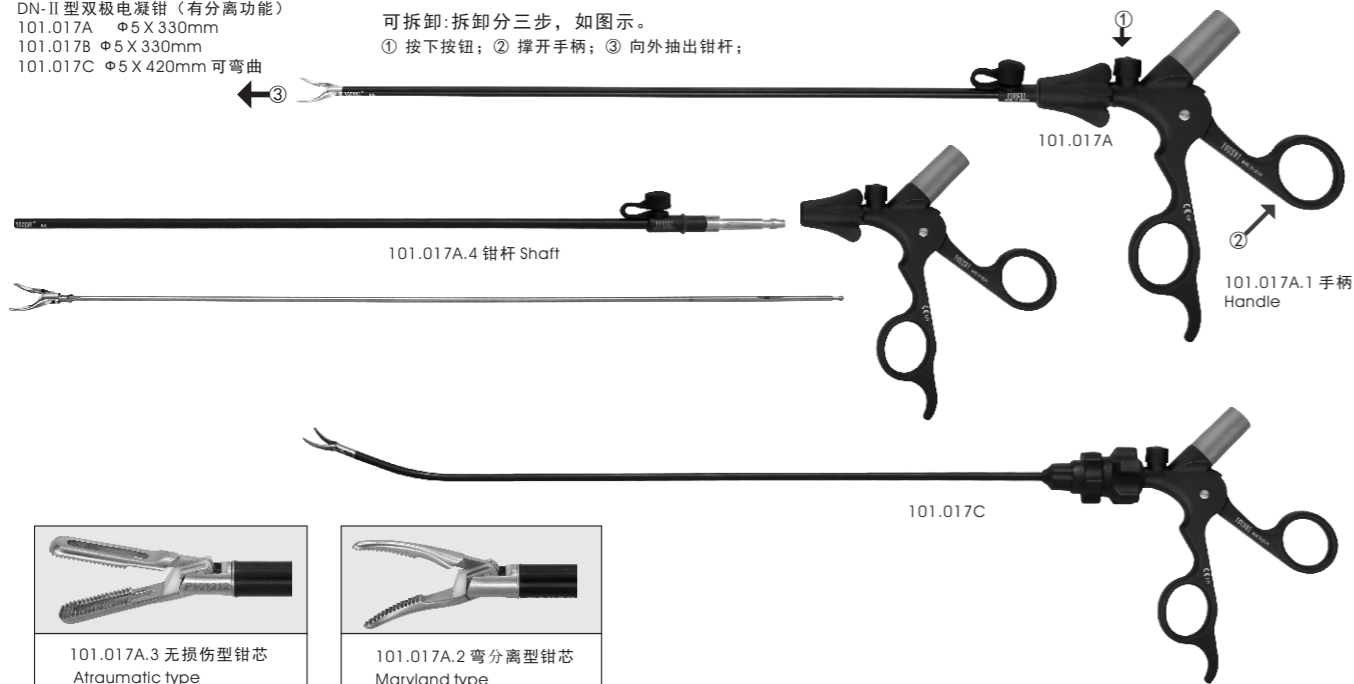

DN-I 型双极电凝钳 (塑柄 plastic handle)  
101.015A  $\Phi 5 \times 330\text{mm}$

可拆卸: 拆卸分五步, 如图示。Detachable

① 手握手柄, 用拇指向下按按钮; ② 向外抽出钳芯; ③ 旋转转轮直至松开; ④ 向外抽出钳杆; ⑤ 抽出钳子内杆。

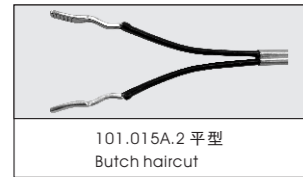
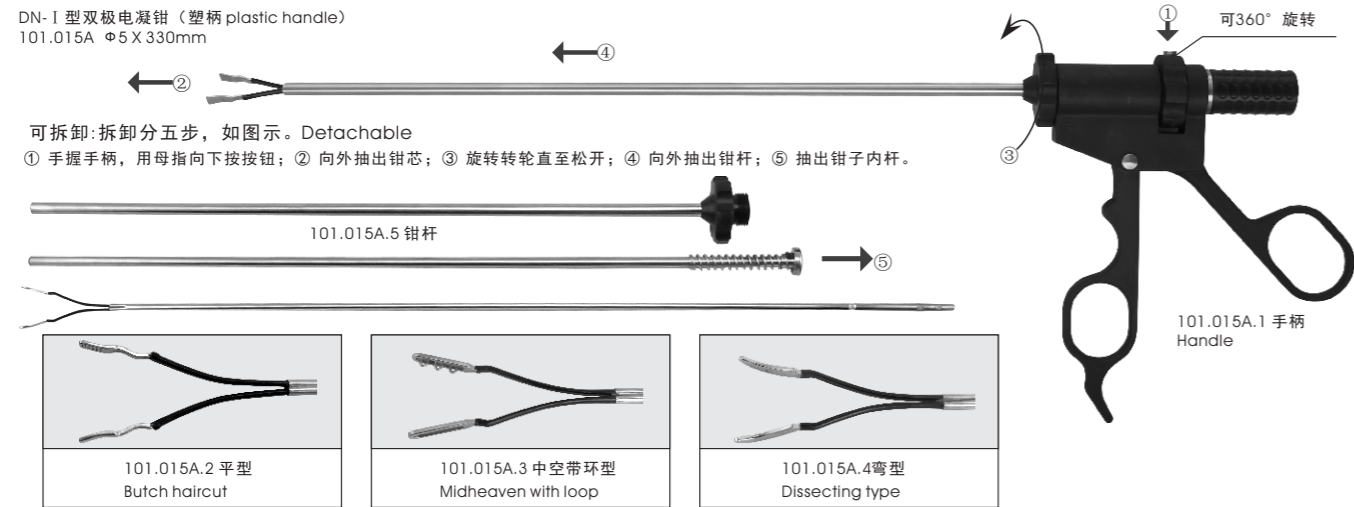

DN-III 型双极电凝钳 (金属柄 metal handle)  
101.015B  $\Phi 5 \times 330\text{mm}$

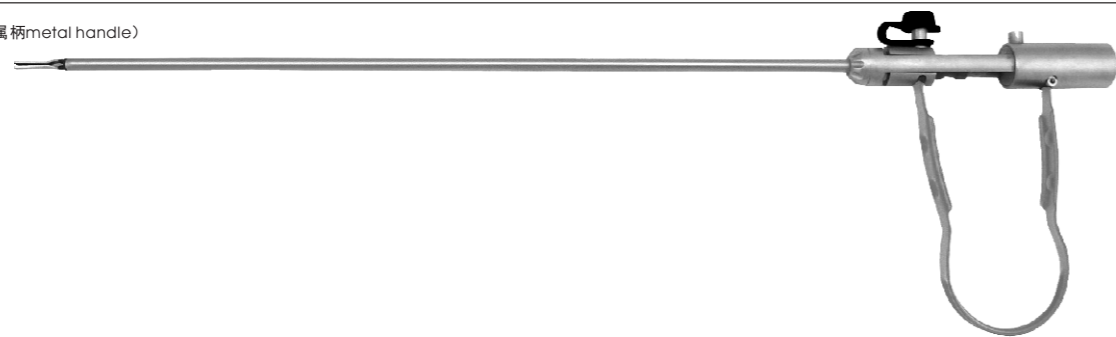

高频电缆线 (双极) Bipolar cable  
101.093 长度 3000mm



持针钳 Needle-holding forceps

101.031A.1 持针钳 (V型)  
V-Needle-holder forceps  $\Phi 5 \times 330\text{mm}$



101.033CT 持针钳 (钛合金枪型)  
The gun type-Needle-holder forceps  $\Phi 5 \times 330\text{mm}$

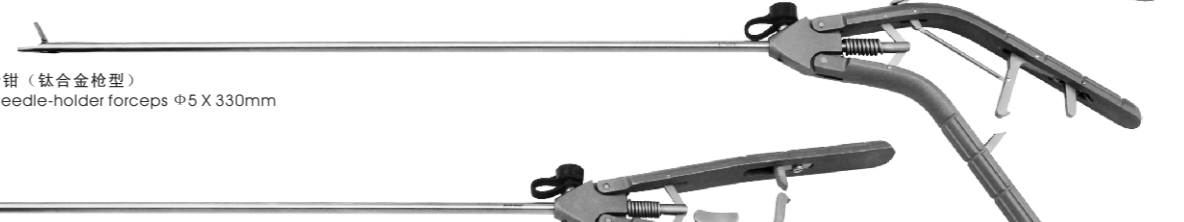

101.033E 持针钳 (钛合金V型)  
V-Needle-holder forceps  $\Phi 5 \times 330\text{mm}$

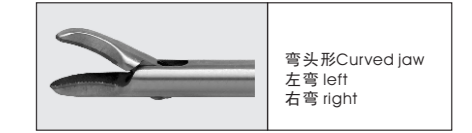
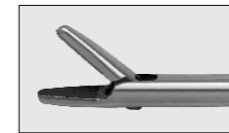
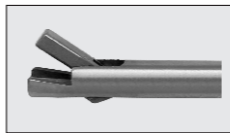
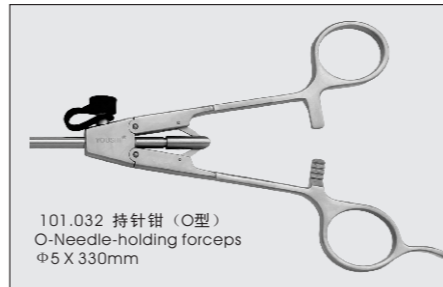

扇形钳 Fan-shaped retractor

101.075 扇形钳 (三叶塑柄)  $\Phi 5 \times 330\text{mm}$   
Fan-shaped forceps, Three leaves



101.075.1 扇形钳 (三叶直柄)  $\Phi 5 \times 330\text{mm}$   
Fan-shaped forceps, Three leaves (Straight handle)



101.076 扇形钳 (五叶)  $\Phi 10 \times 330\text{mm}$   
Fan-shaped retractor, five leaves

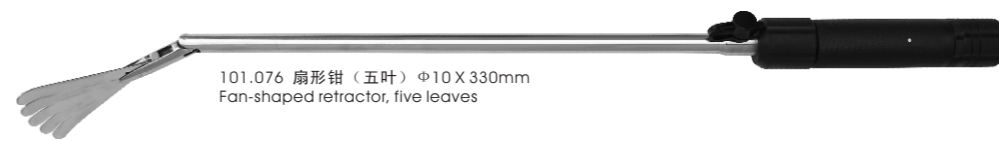

荷包抓钳 Purse Stitching Clamp



YS101.124 荷包抓钳 Purse Stitching Clamp

持针钳 Needle-holding forceps

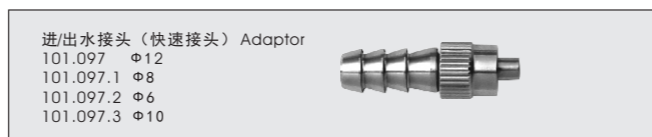
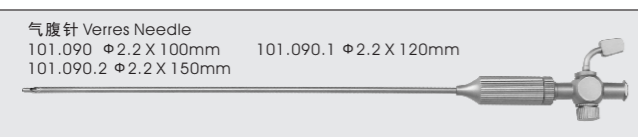
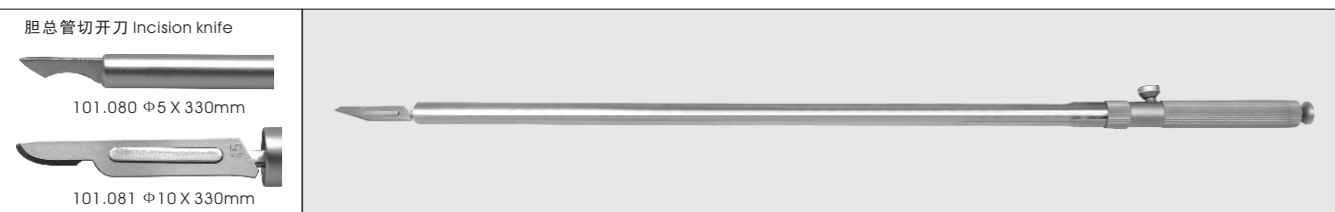
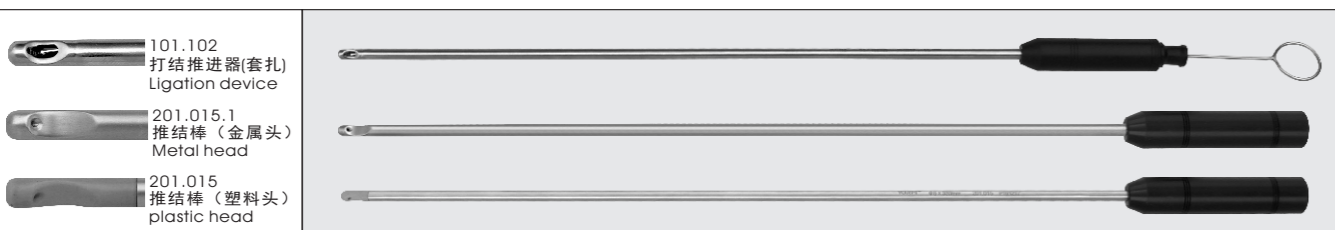
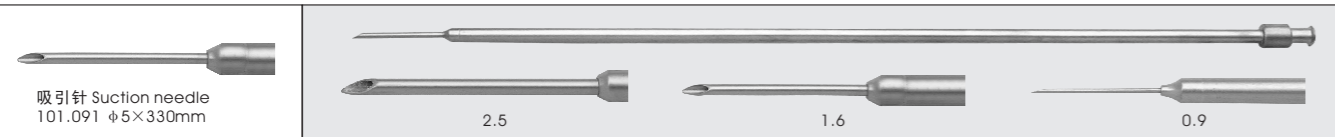
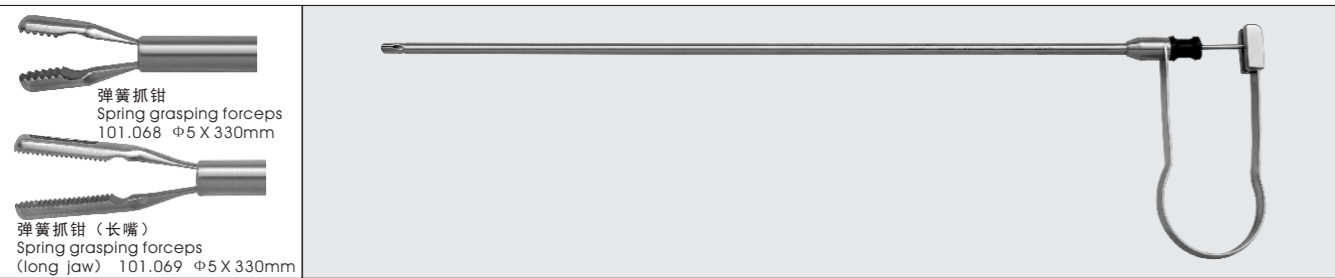
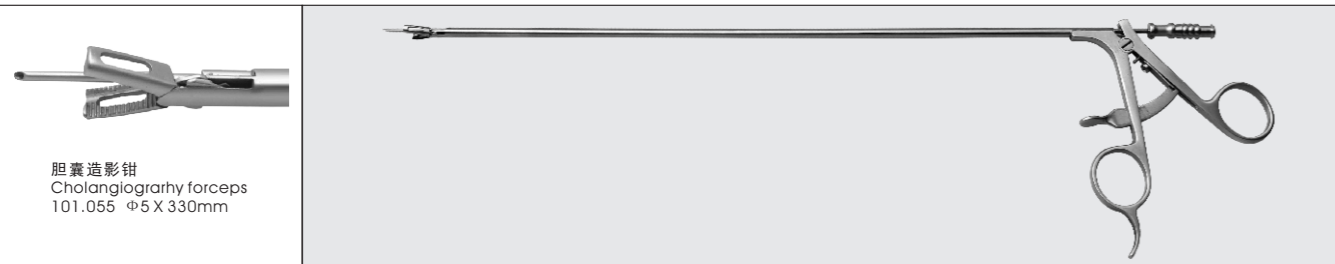

穿刺器 Trocar

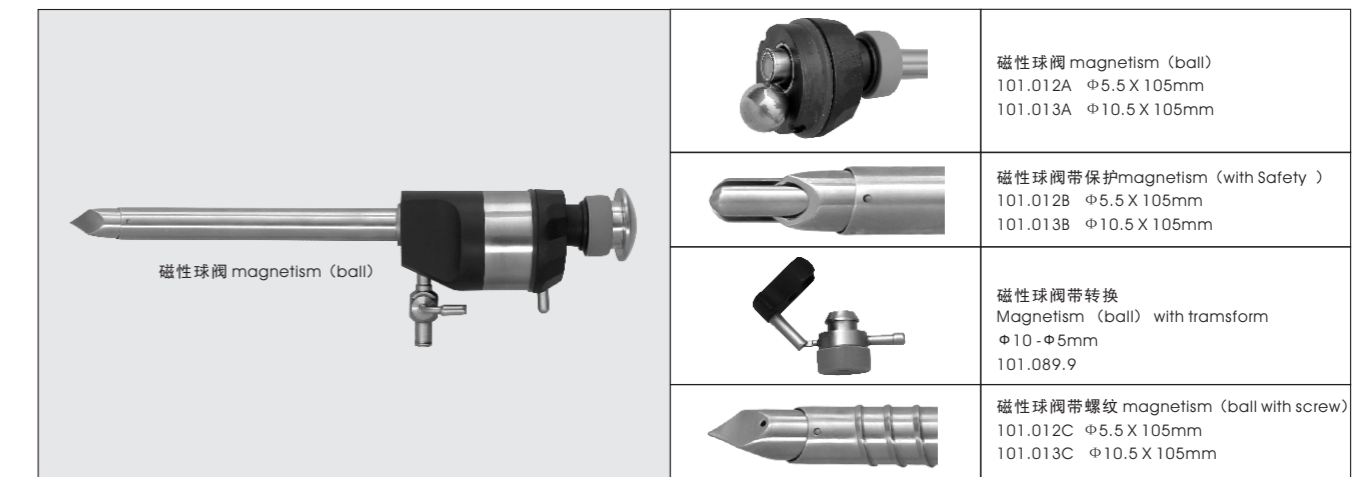
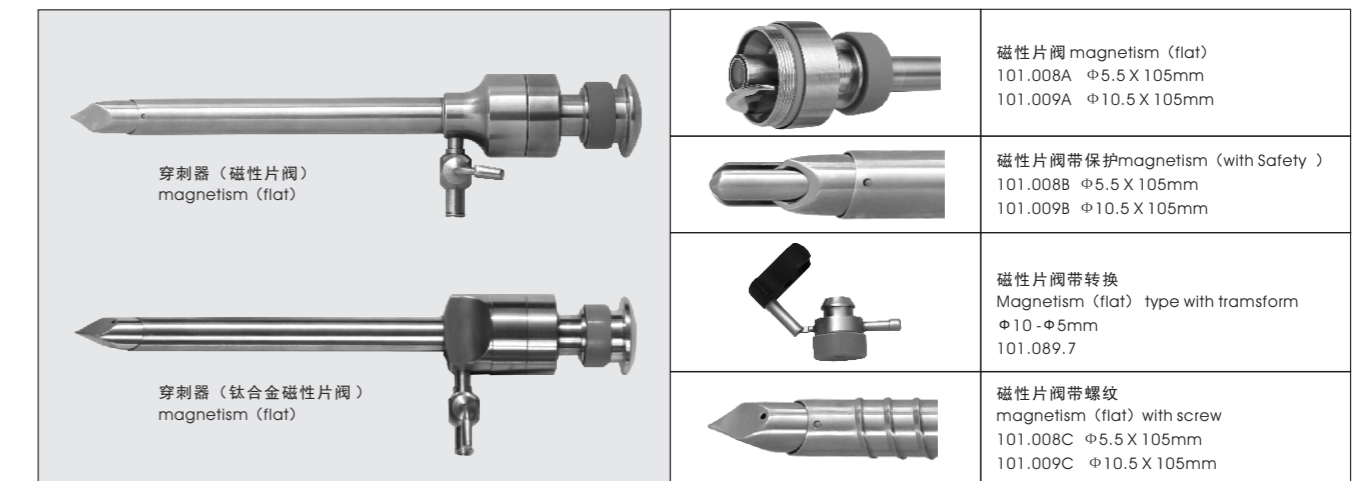
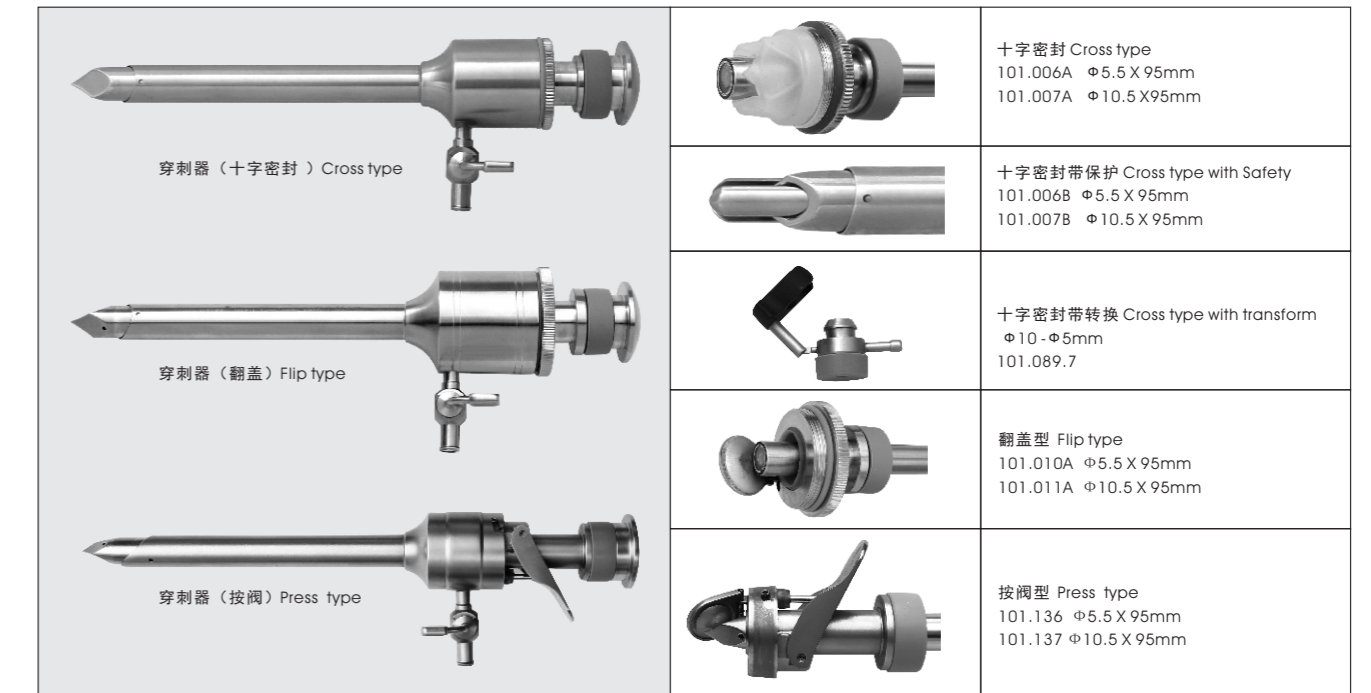

电凝器械 Electric instruments



**电钩 Electric-Hook**  
101.082  $\phi 5 \times 330\text{mm}$   
102.020  $\phi 3 \times 300\text{mm}$   
103.017  $\phi 5 \times 210\text{mm}$

**电钩 Electric-Hook**  
101.082.1  $\phi 5 \times 330\text{mm}$   
102.020.1  $\phi 3 \times 300\text{mm}$   
103.017.1  $\phi 5 \times 210\text{mm}$

**电钩(陶瓷) Electric-Hook (ceramic head)**  
101.082.2  $\phi 5 \times 330\text{mm}$   
102.020.2  $\phi 3 \times 300\text{mm}$   
103.017.2  $\phi 5 \times 210\text{mm}$

**电钩 Electric-Hook**  
101.082.3  $\phi 5 \times 330\text{mm}$   
102.020.3  $\phi 3 \times 300\text{mm}$   
103.017.3  $\phi 5 \times 210\text{mm}$

**电棒 Electric-Ballpoint**  
101.083  $\phi 5 \times 330\text{mm}$   
102.021  $\phi 3 \times 300\text{mm}$   
103.018  $\phi 5 \times 210\text{mm}$

**电棒(冲吸) Electric-Ballpoint**  
101.083.1  $\phi 5 \times 330\text{mm}$   
102.021.1  $\phi 3 \times 300\text{mm}$   
103.018.1  $\phi 5 \times 210\text{mm}$

**电铲 Electric-Spud**  
101.084  $\phi 5 \times 330\text{mm}$   
102.022  $\phi 3 \times 300\text{mm}$

**电钩(针型) Electric-Hook**  
101.085  $\phi 5 \times 330\text{mm}$   
102.023  $\phi 3 \times 300\text{mm}$

**电钩(刀型) Electric-Hook**  
101.086  $\phi 5 \times 330\text{mm}$   
102.024  $\phi 3 \times 300\text{mm}$

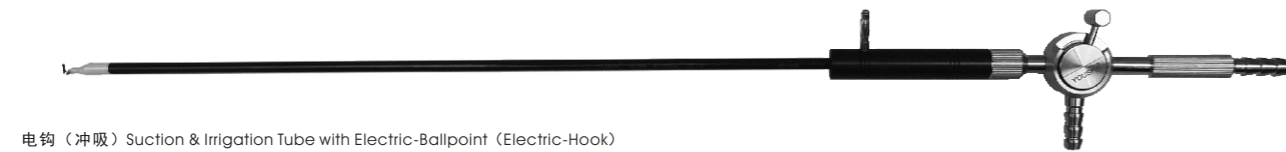

电钩(冲吸) Suction & Irrigation Tube with Electric-Ballpoint (Electric-Hook)  
101.088  $\phi 5 \times 330\text{mm}$

冲吸吸引器 Suction & Irrigation Tube

**冲吸器 Suction & Irrigation Tube (推阀 push type)**  
101.034  $\phi 5 / \phi 10 \times 330\text{mm}$   
102.019  $\phi 2.8 \times 300\text{mm}$   
103.016  $\phi 5 \times 210\text{mm}$

**冲吸器 Suction & Irrigation Tube (按阀 Knob-operated control)**  
101.035  $\phi 5 / \phi 10 \times 330\text{mm}$

**冲吸器 Suction & Irrigation Tube (枪式 Pistol type)**  
101.035.2  $\phi 5 / \phi 10 \times 330\text{mm}$

腹壁缝合钳 Bile Duct Forcep

101.118 腹壁缝合针(疝气修补器) Hernia needle  $\phi 2.5\text{mm}$

101.119 腹壁缝合钳(疝气钳) 101.119.1 上开口  
101.119.2 下开口

101.120 腹壁缝合针(疝气针) Hernia needle  $\phi 1.5\text{mm}$

101.120.1 腹壁缝合针(疝气针) Hernia needle  $\phi 2.2\text{mm}$

101.122 腹壁缝合针(疝气针/直扁) Hernia needle  $\phi 1.8\text{mm}$

101.122.1 腹壁缝合针(疝气针/弯扁) Hernia needle  $\phi 1.8\text{mm}$

101.121 腹壁缝合钳(疝气针) Hernia forcep

101.123 腹壁缝合针(疝气针) Hernia needle  $\phi 1.5\text{mm}$

101.123.1 腹壁缝合针(疝气针) Hernia needle  $\phi 1.5\text{mm}$

结扎缝合引线器(上开口/下开口) Hernia forcep  $\phi 2.5\text{mm}$  101.119.2

胸腔穿刺器 Thoracentesis trocar

105.001 胸腔穿刺器 Thoracentesis trocar  $\phi 5.5 \times 70\text{mm}$

105.002 胸腔穿刺器 Thoracentesis trocar  $\phi 10.5 \times 70\text{mm}$

105.003 胸腔穿刺器 Thoracentesis trocar  $\phi 12.5 \times 70\text{mm}$

靶式钳 Target-type forcep

101.095 组织抓取钳(靶式) Target-type forcep  $\phi 10 \times 330\text{mm}$



哈巴狗抓钳 Forcep

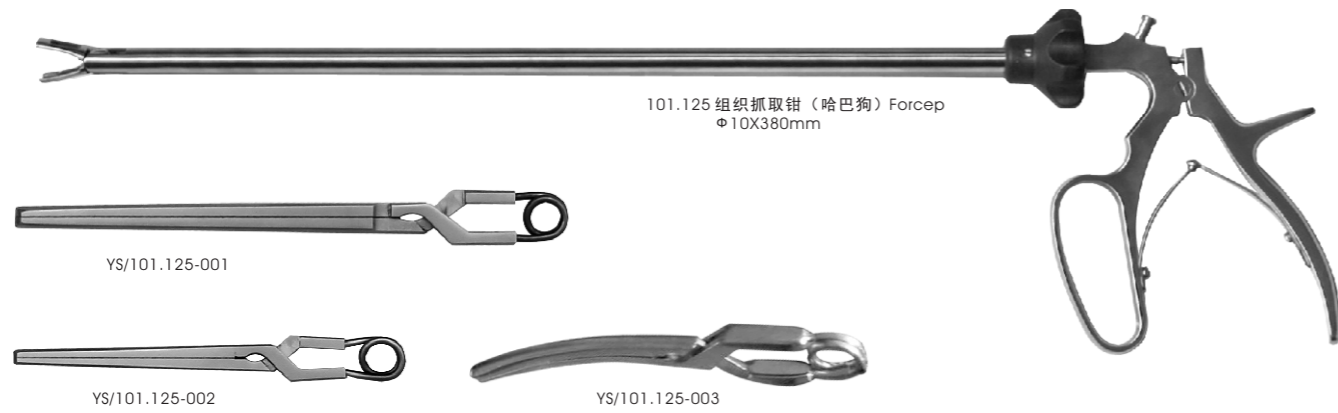

YS104 甲状腺手术器械 Thyroid Instruments

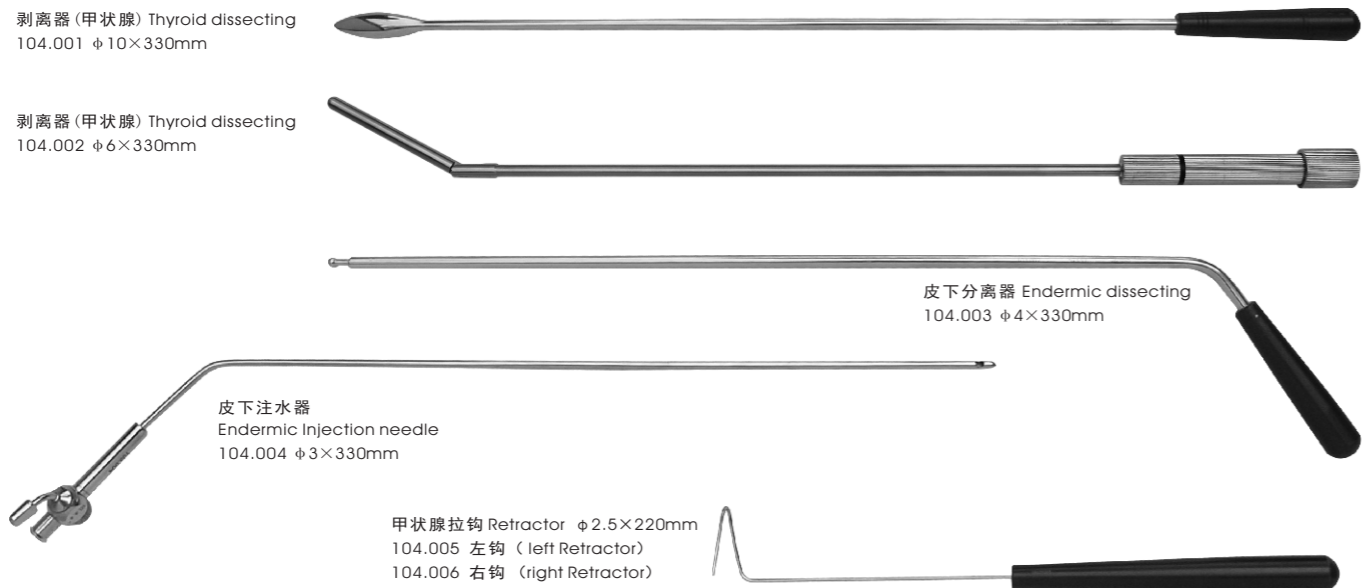

JLG型拉钩 finger

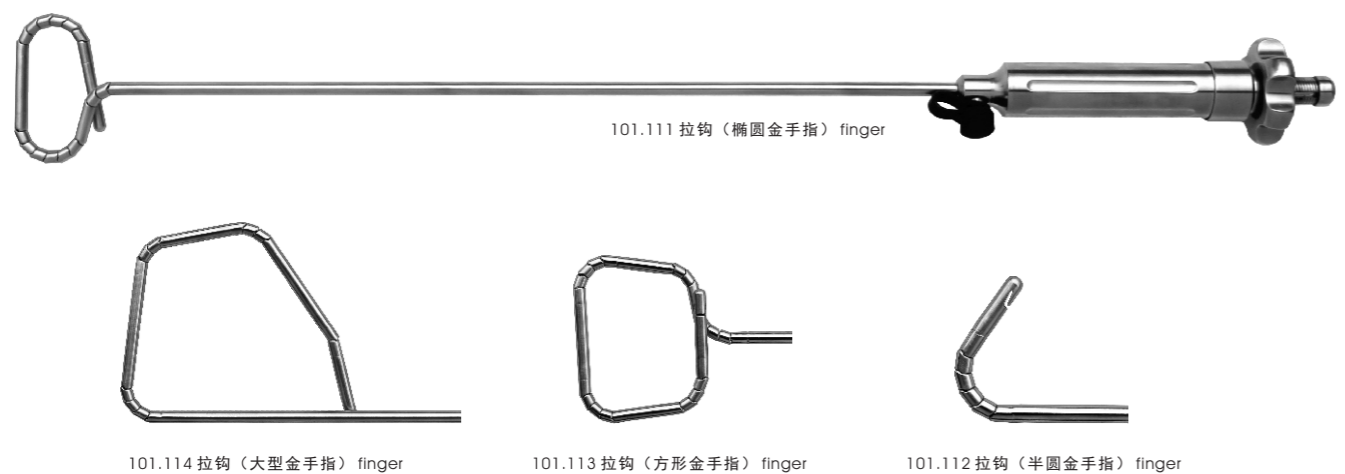

YS113 可旋转可弯曲手术器械

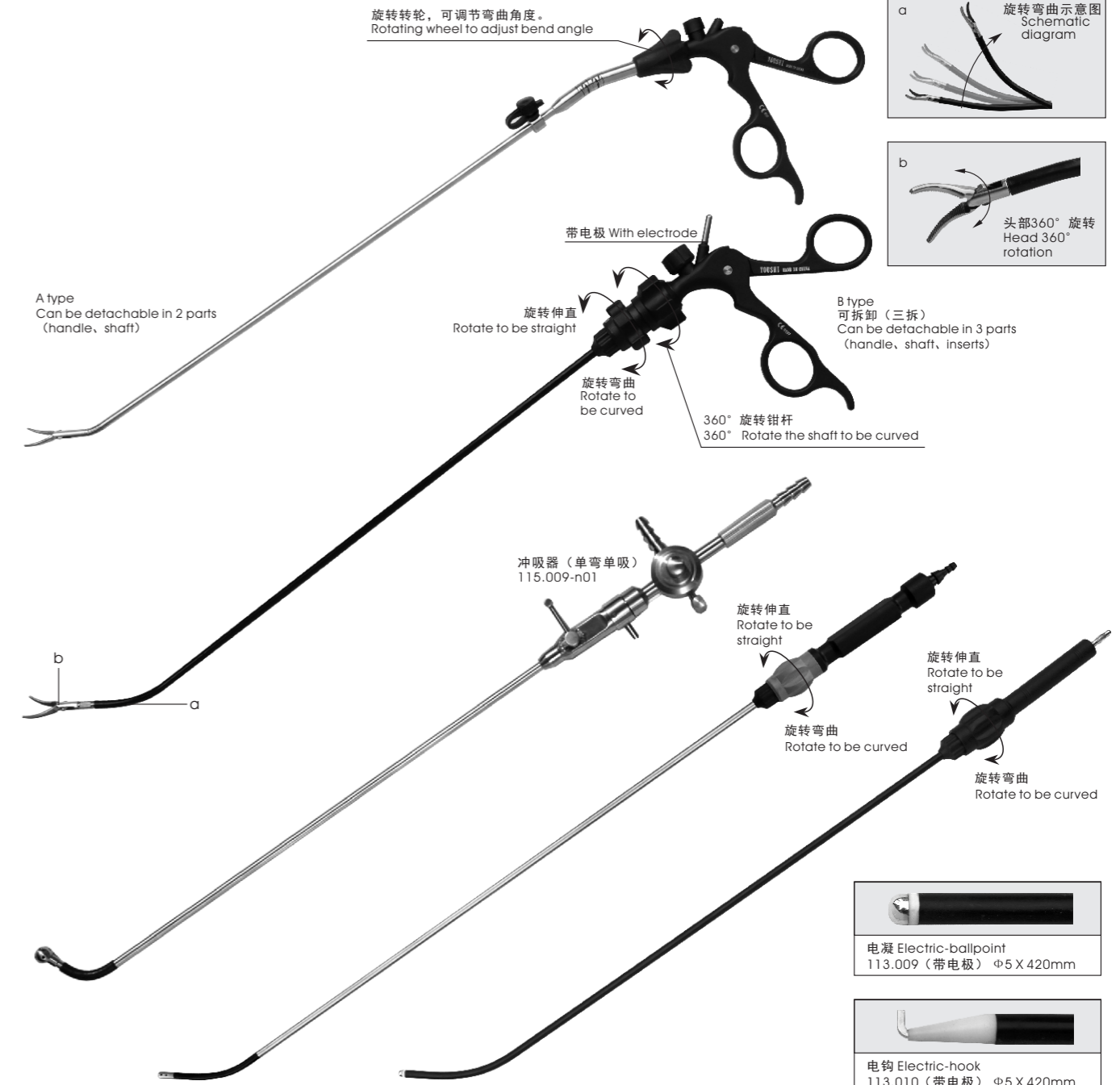

YS112 单孔（经脐部）腹腔镜手术器械 Single port instruments (through navel)

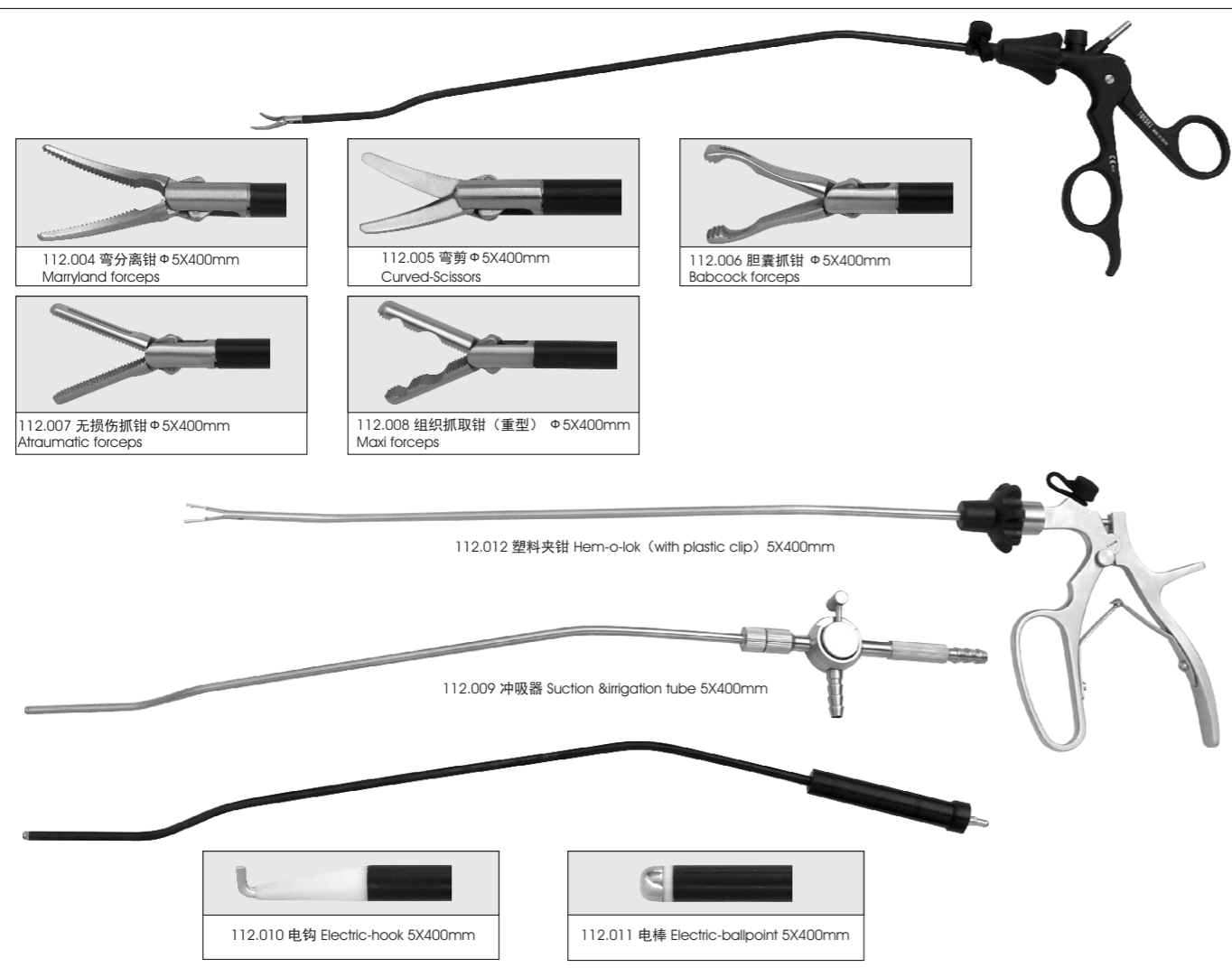
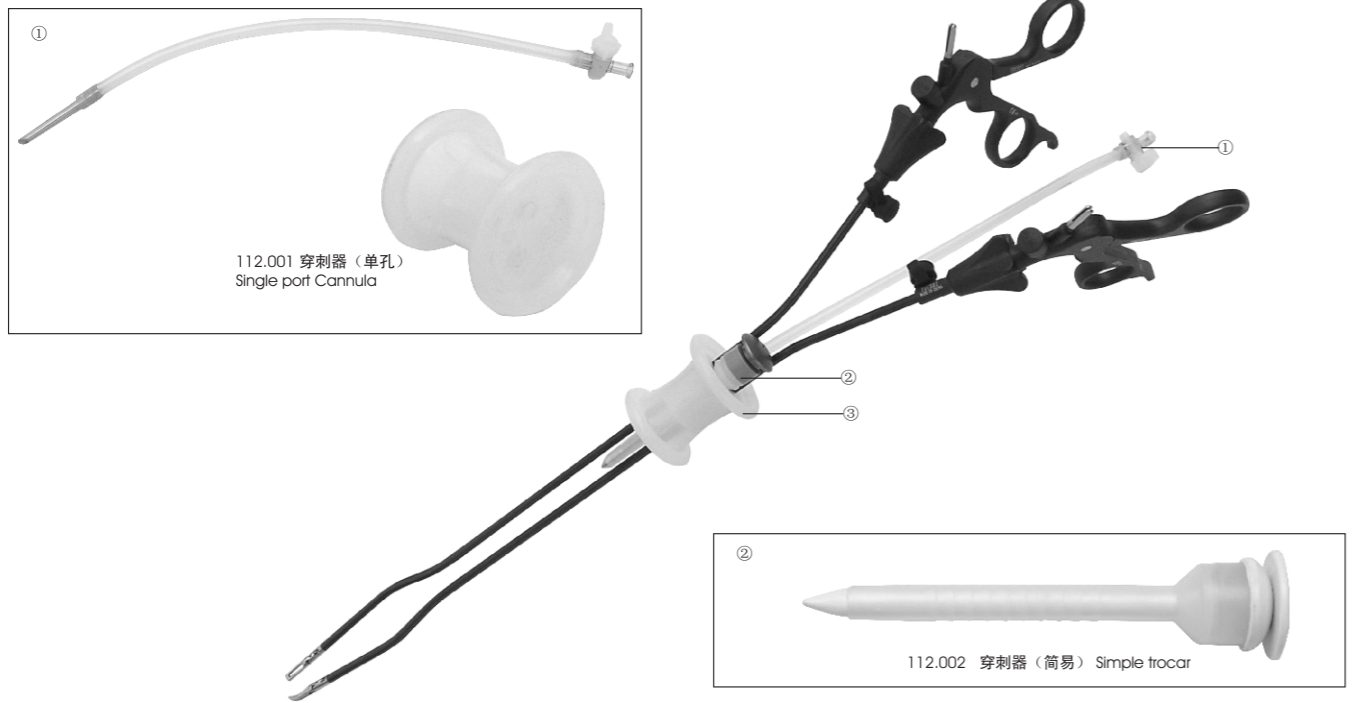

YS115 XW型胸腔外科手术器械 Thoracoscopy instruments

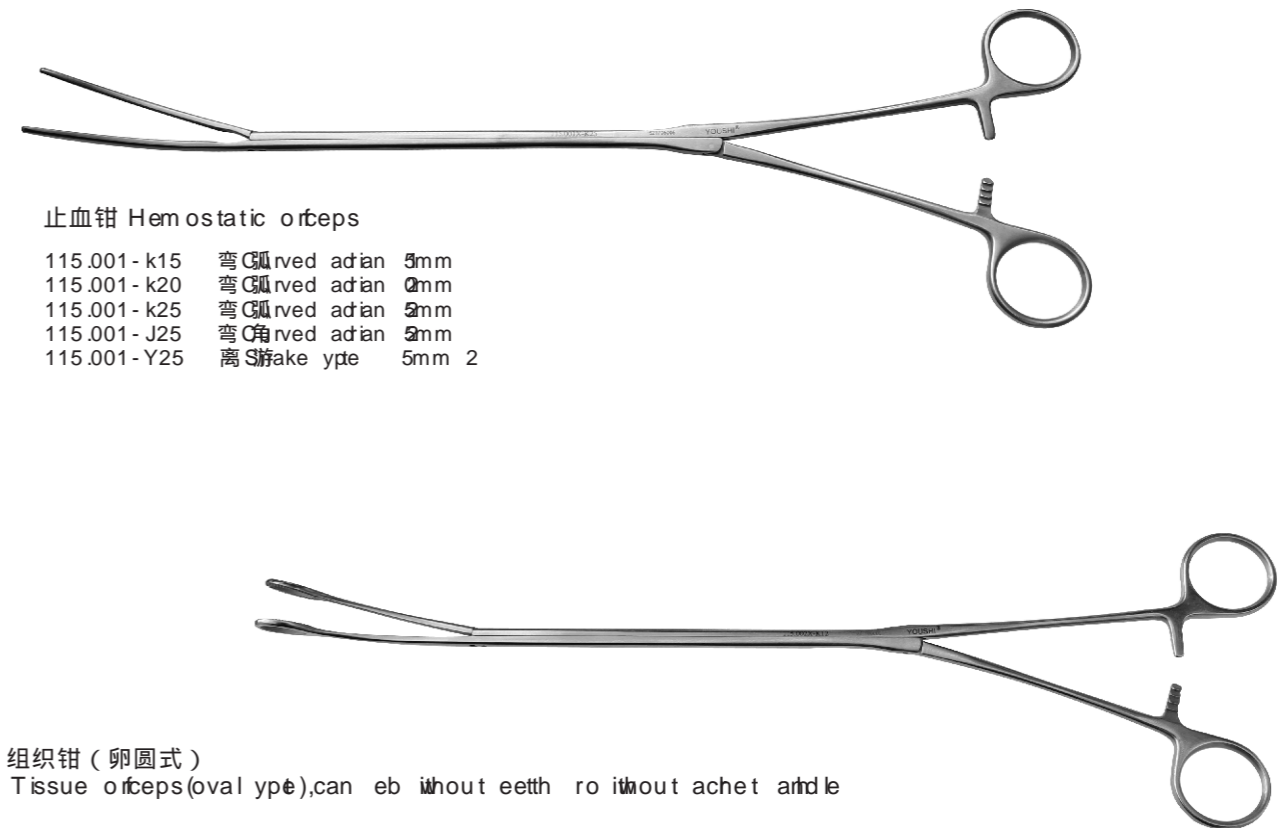

- 115.001-k15 弯弧形 5mm
- 115.001-k20 弯弧形 2mm
- 115.001-k25 弯弧形 5mm
- 115.001-J25 弯弧形 5mm
- 115.001-Y25 离型 5mm 2

- 115.002-k08 总长 Length 340mm 卵圆 head diameter 8mm 齿带 teeth 带不为 bk
- 115.002-k10 总长 Length 340mm 圆 head diameter 10mm 齿 with teeth 带齿为 w k
- 115.002-k12 总长 Length 340mm 圆 head diameter 12mm 齿 with teeth 带不带齿为 bw k
- 115.002-m08 总长 Length 360mm 卵圆 head diameter 8mm 齿带 teeth
- 115.002-m10 总长 Length 360mm 圆 head diameter 10mm 齿 with teeth
- 115.002-m12 总长 Length 360mm 圆 head diameter 12mm 齿 with teeth
- 115.002-n08 总长 Length 420mm 圆 head diameter 8mm 齿带 teeth
- 115.002-n10 总长 Length 420mm 圆 head diameter 10mm 齿 with teeth
- 115.002-n12 总长 Length 420mm 圆 head diameter 12mm 齿 with teeth

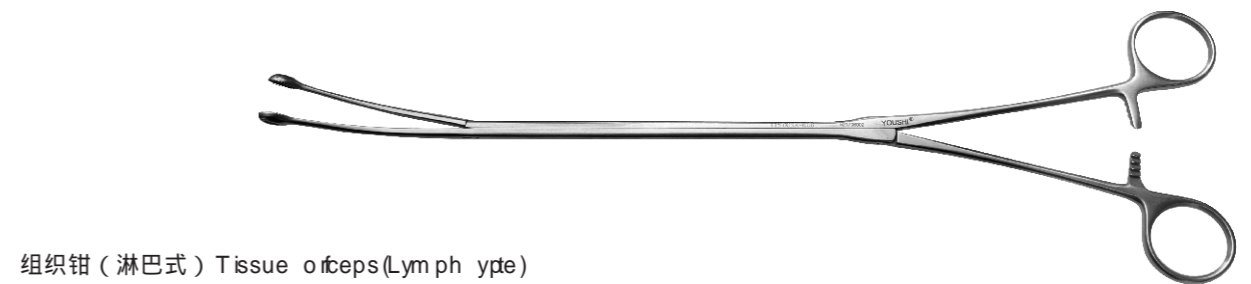

- 115.003-k09 总长 length, 340mm 弯头径 curved head diameter 9mm
- 115.003-k12 总长 length, 340mm 头径 curved head diameter 12mm
- 115.003-m09 总长 length, 360mm 头径 curved head diameter 9mm
- 115.003-m12 总长 length, 360mm 头径 curved head diameter 12mm

YS115 XW型胸腔外科手术器械 Thoracoscopy instruments

医用剪 Scissors

- 115.005-bk01 总长 length,300mm 头部宽 head width 2.5 mm
- 115.005-bk02 总长 length,300mm 头部宽 head width 3.5 mm
- 115.005-bm01 总长 length,320mm 头部宽 head width 2.5 mm
- 115.005-bm02 总长 length,320mm 头部宽 head width 3.5 mm

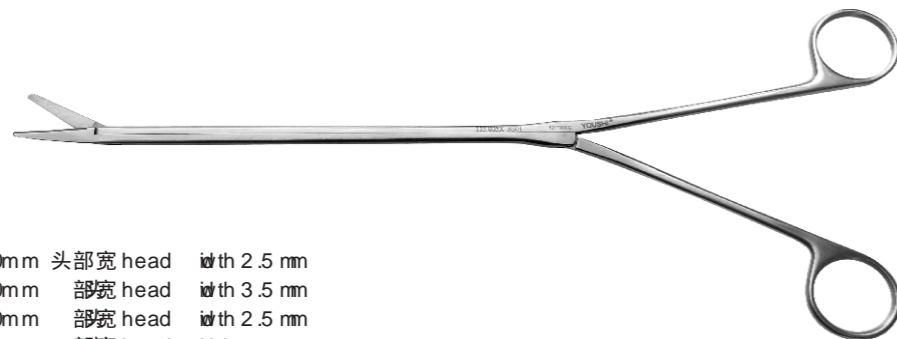

组织钳 (allis式) Tissue forceps (allis type)

- 115.004-k01 总长 length,340mm 尖宽 curved blade width 8mm
- 115.004-k02 总长 length,340mm 尖宽 straight blade width 8mm
- 115.004-m01 总长 length,360mm 尖宽 curved blade width 8mm
- 115.004-m02 总长 length,360mm 尖宽 straight blade width 8mm
- 115.010-k10 总长 length,360mm 蛇头 snake blade width 8mm

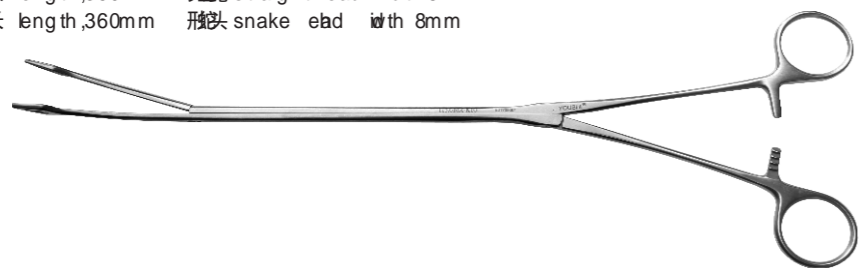
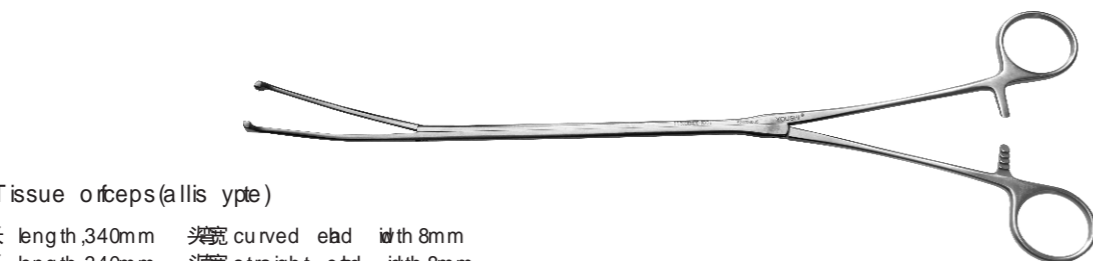

持针钳 Needle holder

- 115.006-k01 总长 length,340mm 头宽 curved blade
- 115.006-m01 总长 length,360mm 头宽 curved blade
- 115.006-k02 总长 length,340mm 头宽 straight blade
- 115.006-m02 总长 length,360mm 头宽 straight blade

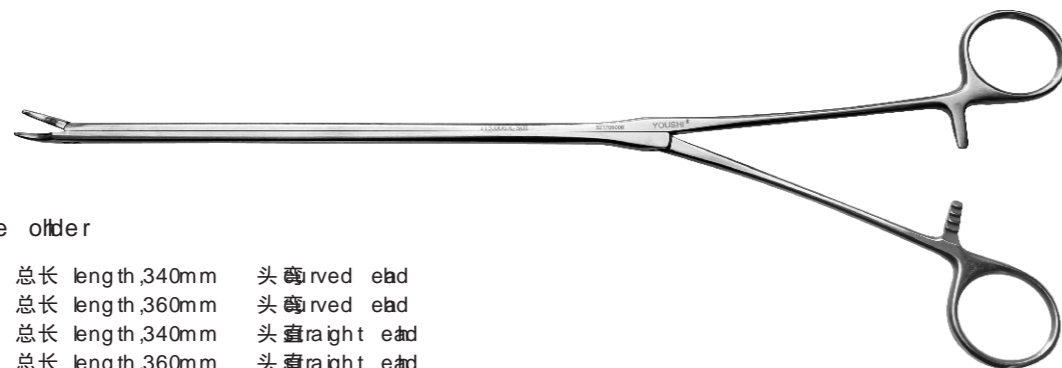

YS115 XW型胸腔外科手术器械 Thoracoscopy instruments

组织钳 (握笔式) Tissue forceps (pen type)

- 115.007-k12 钳头长 head length 12mm  
握笔式手柄 pen type



打结推进器 Knot pusher

- 115.008-s01 右弯 Right curved
- 115.008-L01 左弯 Left curved



- 101.101.2 结推进器 (J形头) - head  $\phi 5 \times 330$ mm



吸引管 Suction irrigation tube

- 115.009-m01 按钮单通 (可转弯) Knot-operated type can be curved
- 115.009-n01 推阀三通 (可转弯) push type, arc be curved
- 115.009-k01 直通六角柄直头 吸液可更换 Straight type, straight blade, hexagonal handle, hangable blade
- 115.009-k02 直通六角柄弯头 Straight type, curved blade, hexagonal handle,



一次性使用医疗手术器械 Disposable instruments

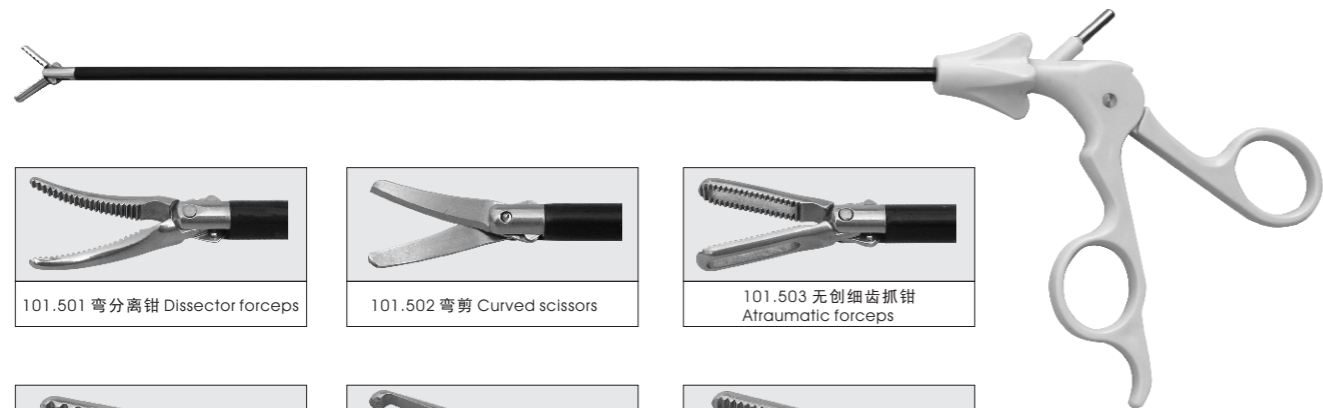

101.501 弯分离钳 Dissector forceps



101.502 弯剪 Curved scissors



101.503 无创细齿抓钳 Atraumatic forceps



101.504 无创粗齿抓钳 Atraumatic forceps



101.505 中空抓钳 Grasping forceps



101.506 钝头抓钳 Blunt grasping forceps

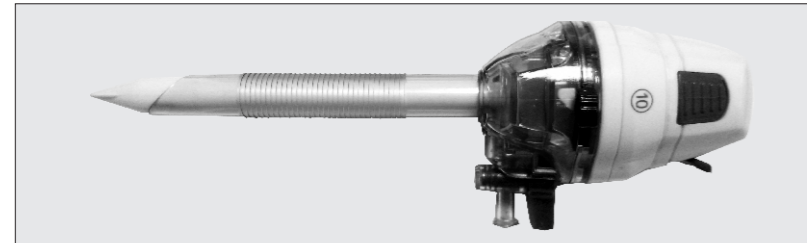

一次性使用穿刺器 Disposable trocar  
701.001  $\Phi$ 5mm  
701.002  $\Phi$ 10mm  
701.003  $\Phi$ 12mm

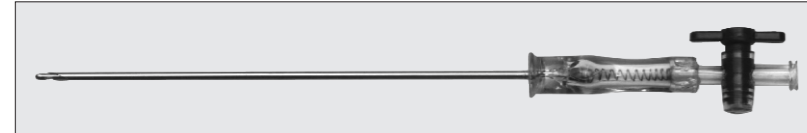

一次性使用气腹针 Disposable veress needle  
701.004  $\Phi$ 2.1mm

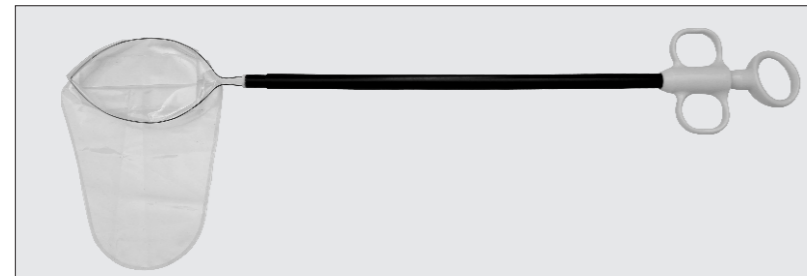

一次性取物袋 Disposable endobag  
101.565

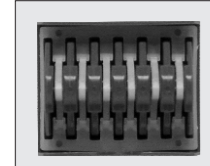

101.570 结扎钉 (闭合夹) Hem-o-lok 加大号 544250



101.571 结扎钉 (闭合夹) Hem-o-lok 大号 544240



101.572 结扎钉 (闭合夹) Hem-o-lok 中大号 544230



101.575 钛夹 Titanium clip 04# (大号)



101.576 钛夹 Titanium clip 03# (中扁)



101.577 钛夹 Titanium clip 2# (小号)



101.578 钛夹 Titanium clip 05# (小号)

YS201 DZ型电动子宫切除器及配套手术器械 Electric uterus-cutter and accessories



穿刺套管 Trocar sleeve

切除刀管 Cutting tube

抓钳 Grasping forceps

201.023 手持电机 (电动马达) Import drive Motor

201.023.2 手持电机连接线

电动子宫切除器 Control unit 201.022

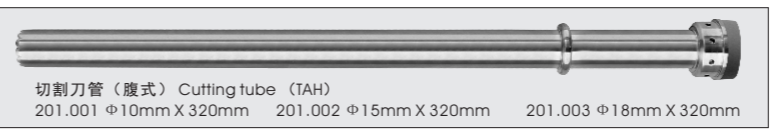

切割刀管 (腹式) Cutting tube (TAH)  
201.001  $\Phi$ 10mm X 320mm 201.002  $\Phi$ 15mm X 320mm 201.003  $\Phi$ 18mm X 320mm

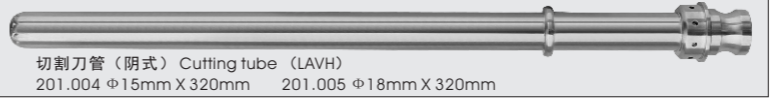

切割刀管 (阴式) Cutting tube (LAVH)  
201.004  $\Phi$ 15mm X 320mm 201.005  $\Phi$ 18mm X 320mm

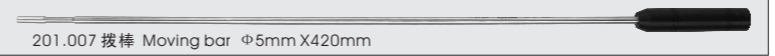

201.007 拨棒 Moving bar  $\Phi$ 5mm X 420mm

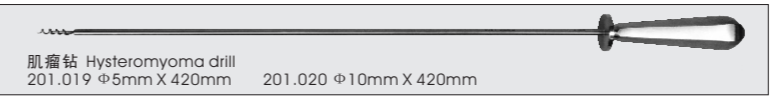

肌瘤钻 Hysteromyoma drill  
201.019  $\Phi$ 5mm X 420mm 201.020  $\Phi$ 10mm X 420mm

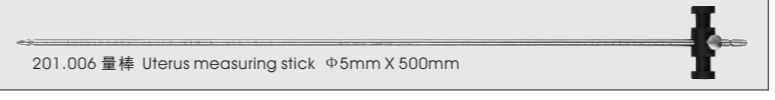

201.006 量棒 Uterus measuring stick  $\Phi$ 5mm X 500mm

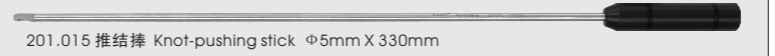

201.015 推结棒 Knot-pushing stick  $\Phi$ 5mm X 330mm

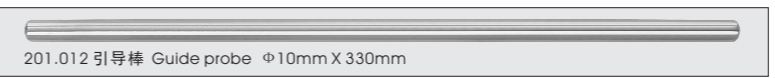

201.012 引导棒 Guide probe  $\Phi$ 10mm X 330mm

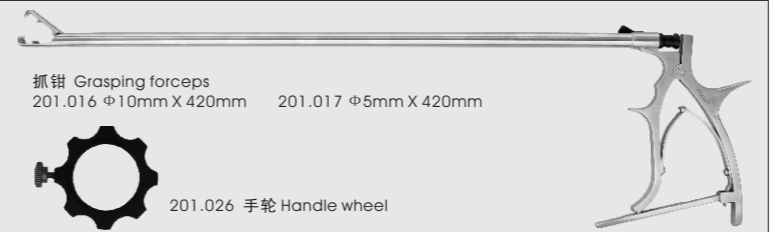

抓钳 Grasping forceps  
201.016  $\Phi$ 10mm X 420mm 201.017  $\Phi$ 5mm X 420mm

201.026 手轮 Handle wheel

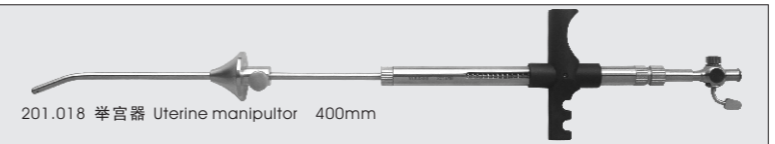

201.018 举宫器 Uterine manipulator 400mm

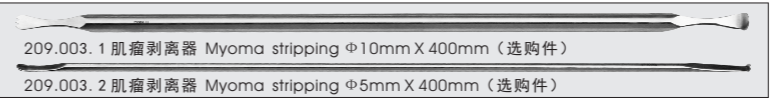

209.003.1 肌瘤剥离器 Myoma stripping  $\Phi$ 10mm X 400mm (选购件)

209.003.2 肌瘤剥离器 Myoma stripping  $\Phi$ 5mm X 400mm (选购件)

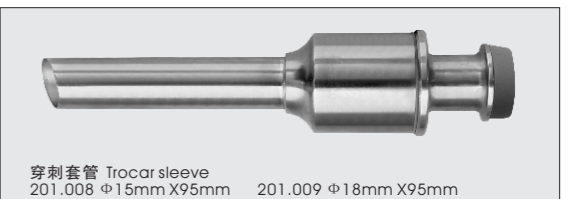

穿刺套管 Trocar sleeve  
201.008  $\Phi$ 15mm X 95mm 201.009  $\Phi$ 18mm X 95mm

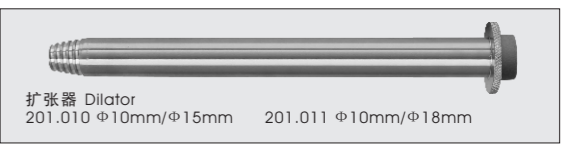

扩张器 Dilator  
201.010  $\Phi$ 10mm/ $\Phi$ 15mm 201.011  $\Phi$ 10mm/ $\Phi$ 18mm



转换器 Reducer  
201.013  $\Phi$ 15mm- $\Phi$ 5mm 201.014  $\Phi$ 18mm- $\Phi$ 5mm

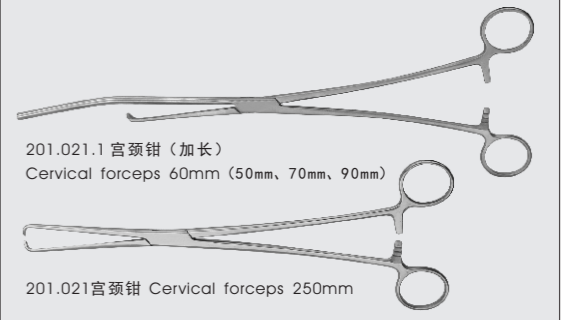

201.021.1 宫颈钳 (加长) Cervical forceps 60mm (50mm, 70mm, 90mm)

201.021 宫颈钳 Cervical forceps 250mm



手持电机 (外壳)

手持电机 (内芯)

YS201A DZ型电动子宫切除器及配套手术器械 Electric uterus-cutter and accessories

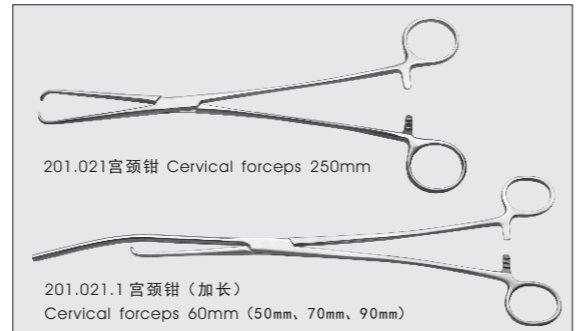
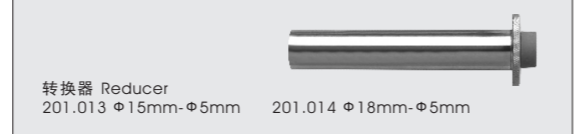
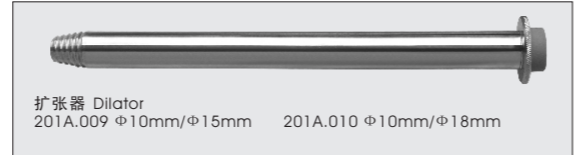
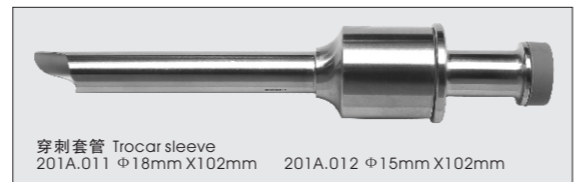
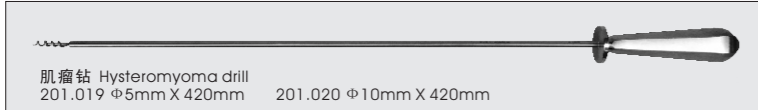
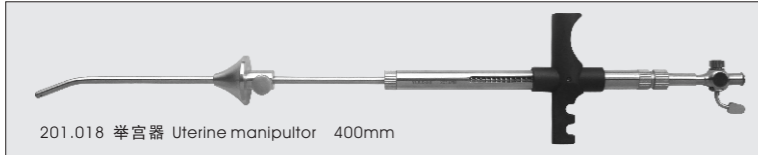
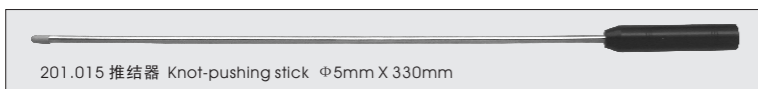
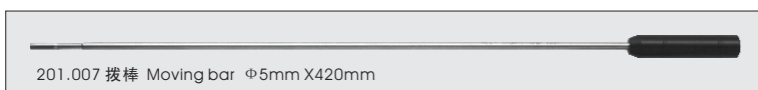
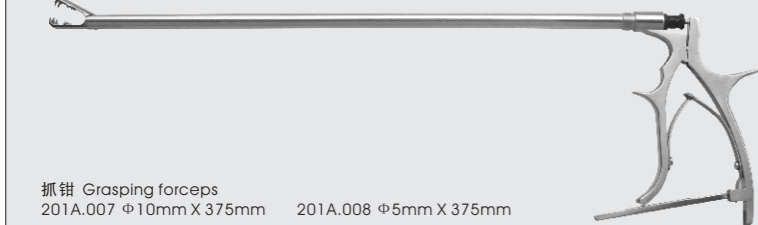
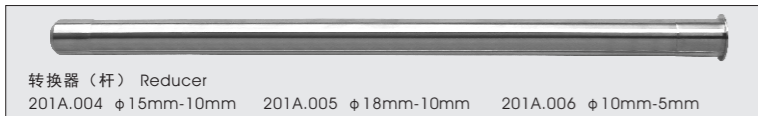
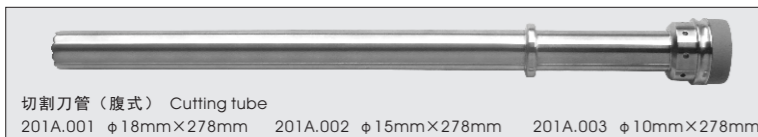

宫腔内窥镜 Hysteroscopy set

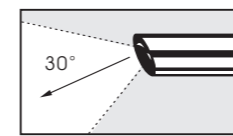

Y2013 直管式内窥镜 (30°) Endoscope  $\phi$ 4 X 302mm  
Y2013.3 直管式内窥镜 (30°) Endoscope  $\phi$ 3 X 302mm

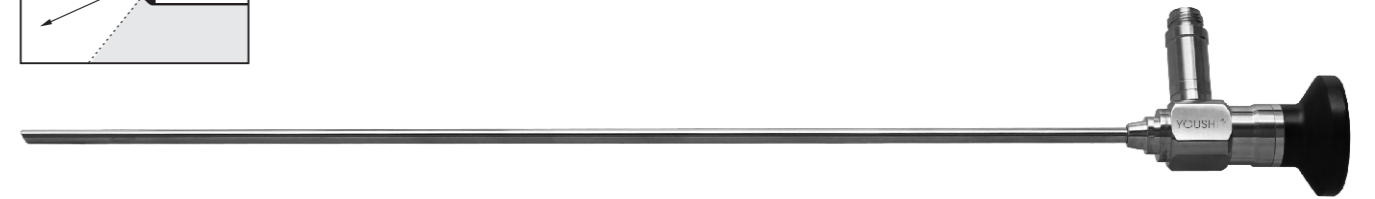

YS202 GQJ-II 型宫腔内窥镜 Hysteroscopy set

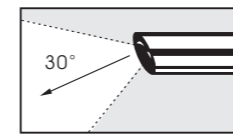

Y20122.2 直管式内窥镜 (旁视) Endoscope

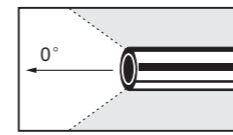

Y2010 直管式内窥镜 (0°) Endoscope

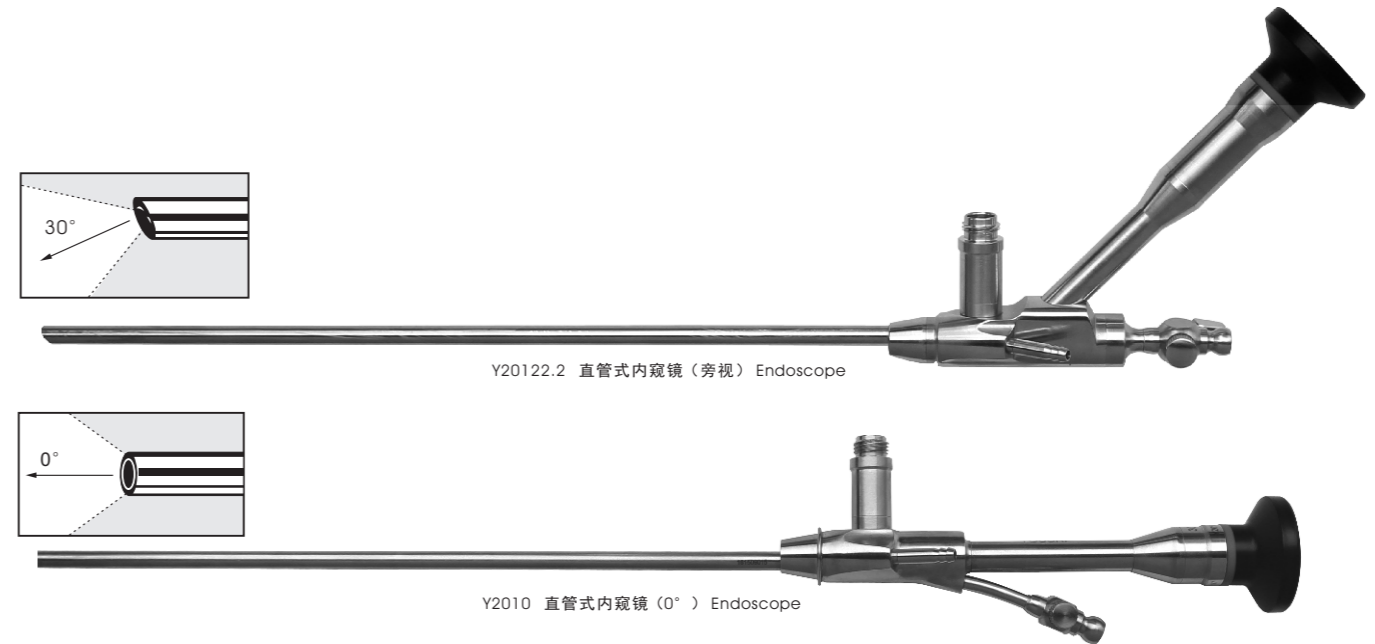

YS203A GQJ-I型宫腔内窥镜（检查） Hysteroscopy set (inspection)

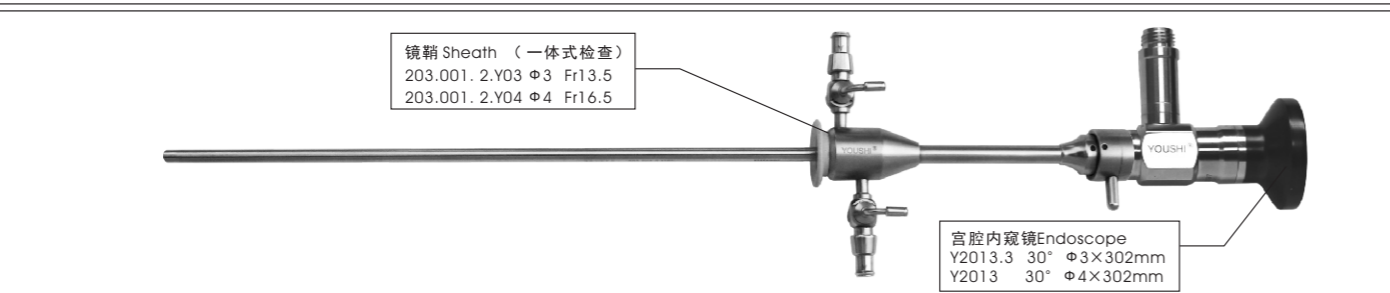
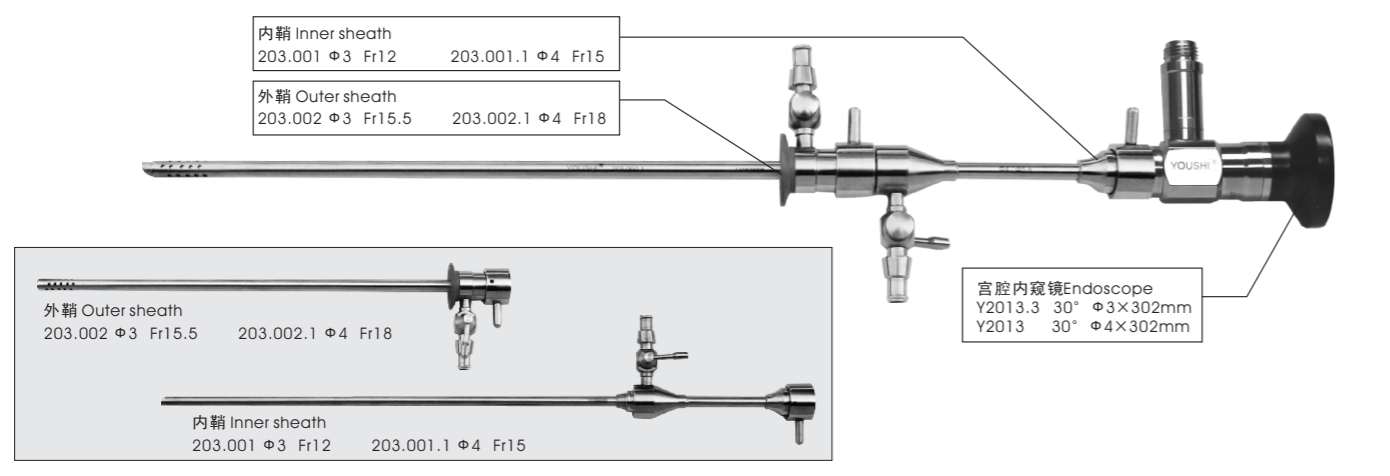

YS203B GQJ-III型宫腔内窥镜（操作） Hysteroscopy set (work)

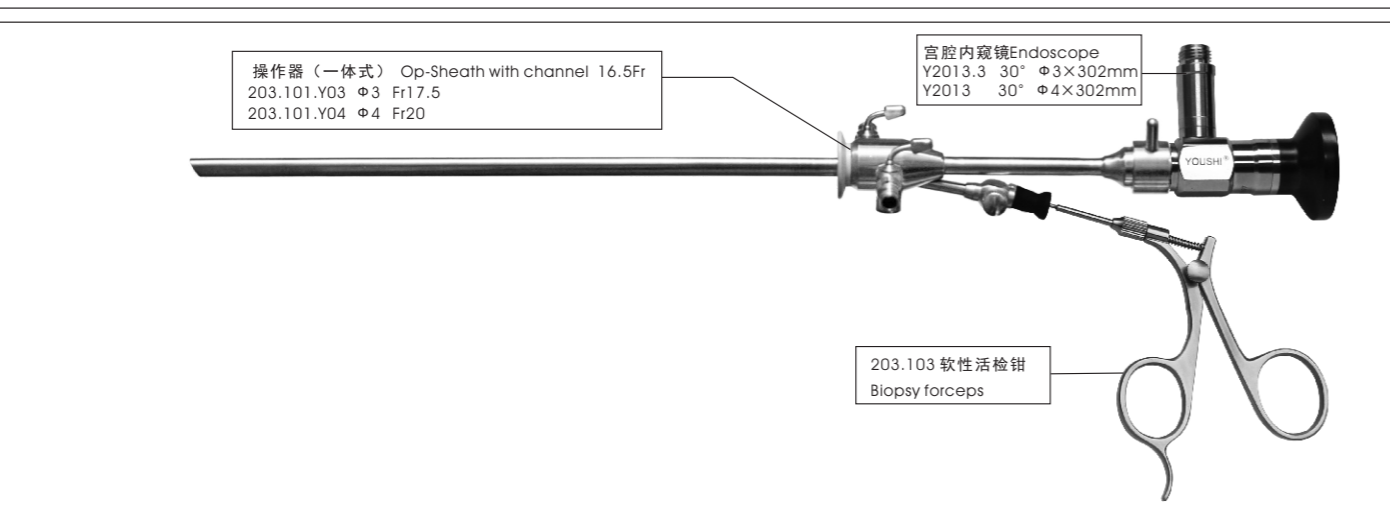
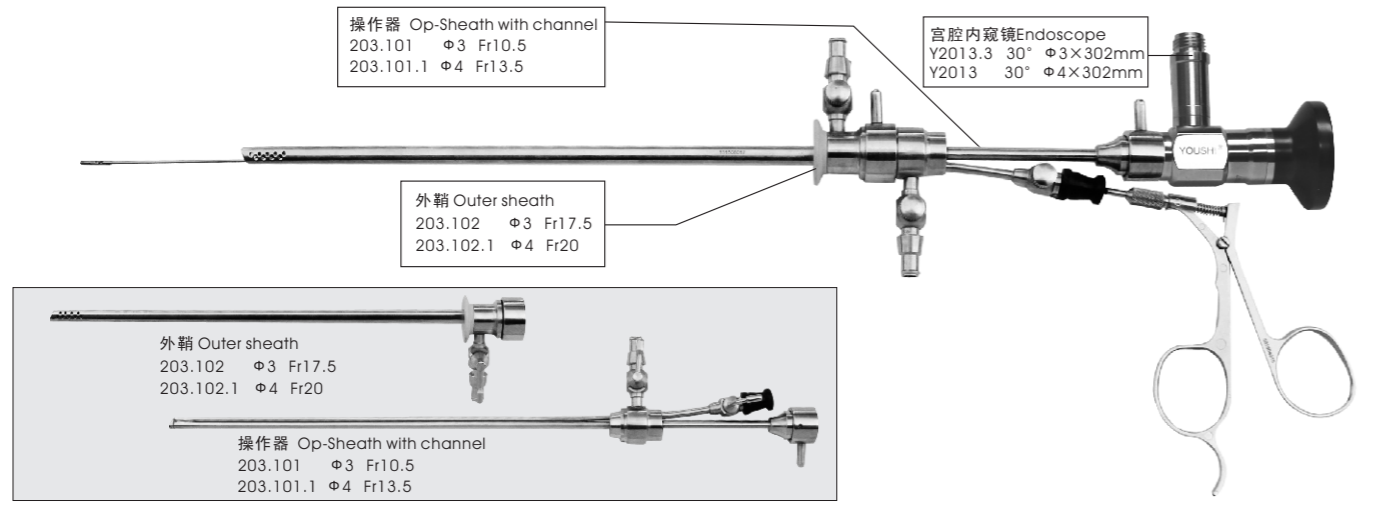

YS207A DC型多功能子宫操纵器 Multi-functional uterus apparatus

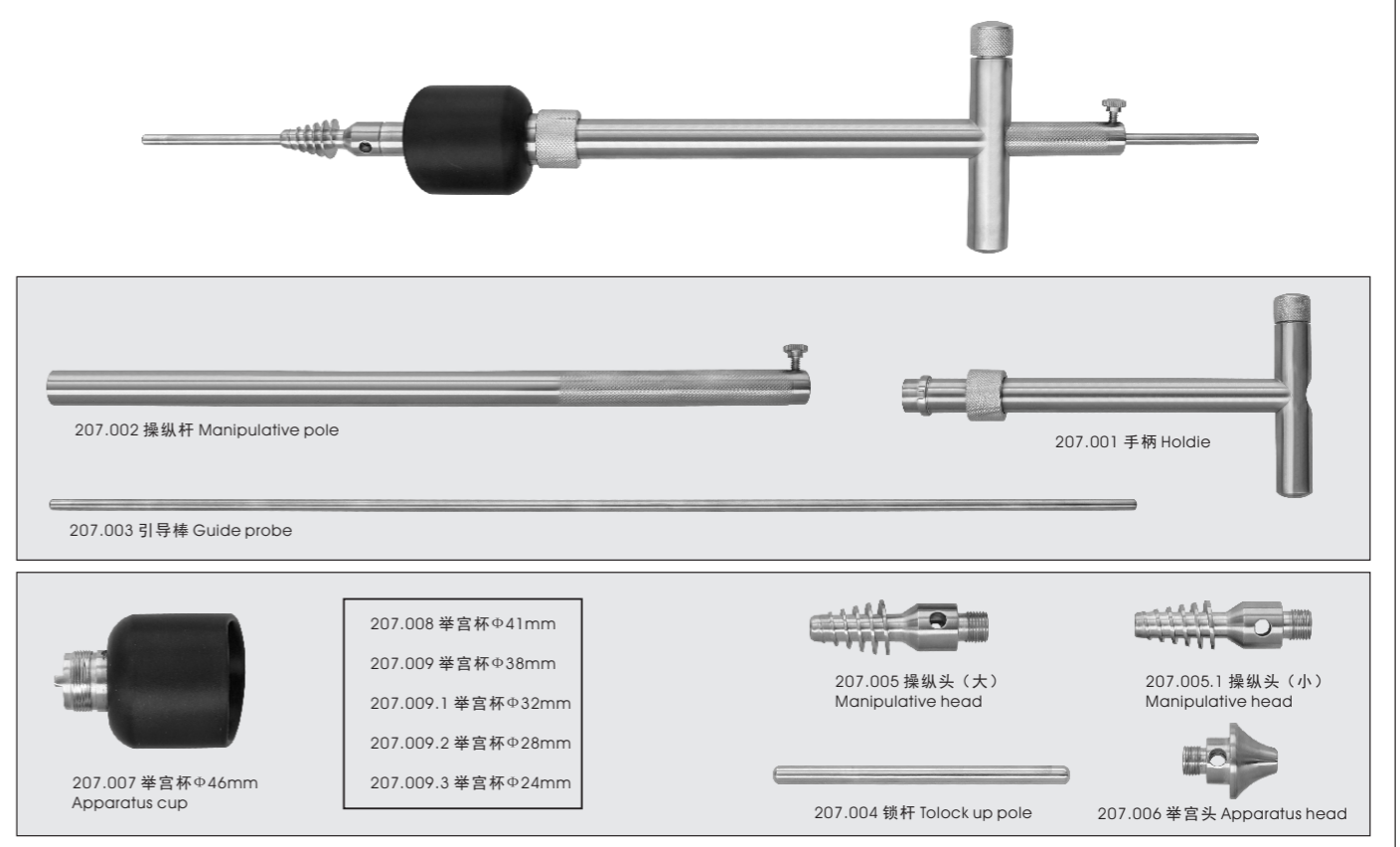

YS207B DC型多功能子宫操纵器 Multi-functional uterus apparatus

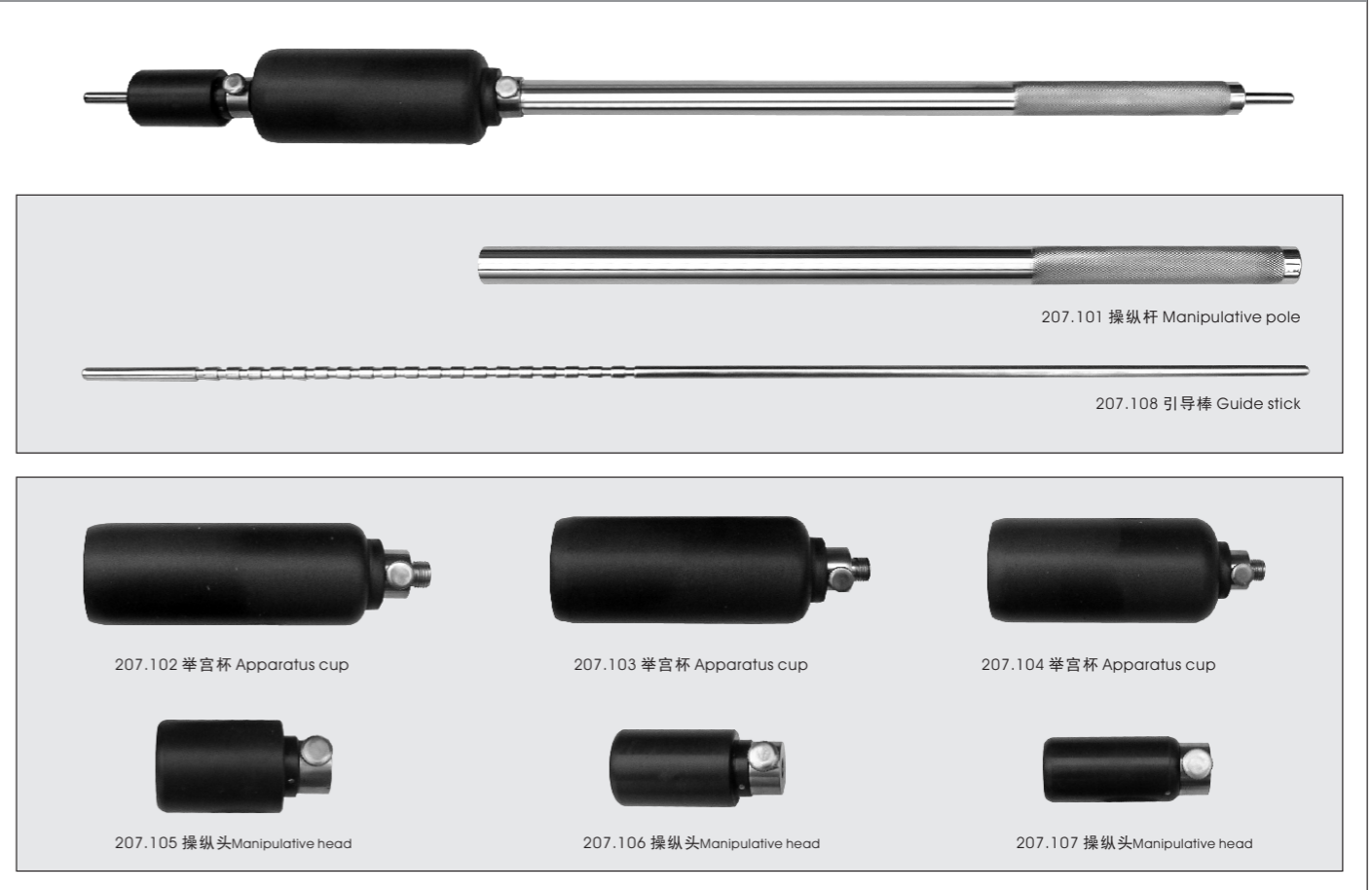

YS207C DC型多功能子宫操纵器 Multi-functional uterus apparatus

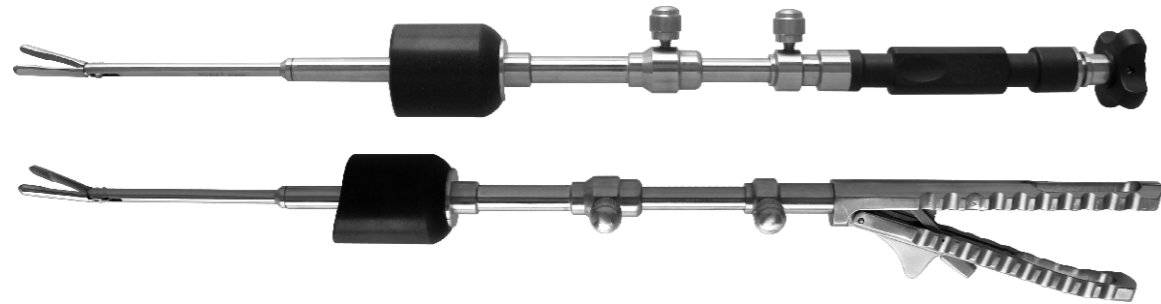

207.211 操纵杆 (旋式) Rotating manipulator

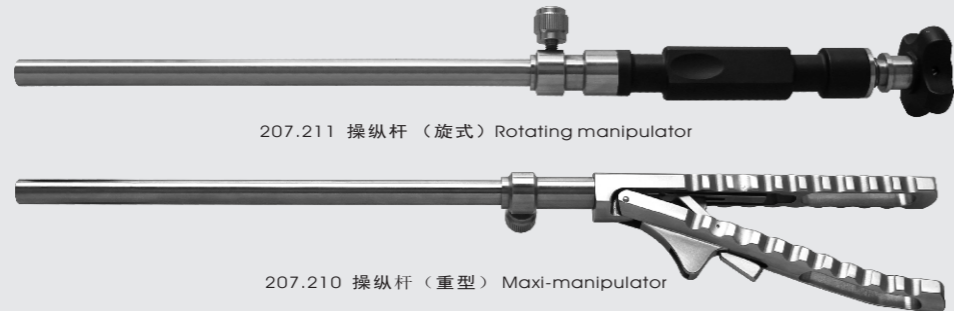

207.210 操纵杆 (重型) Maxi-manipulator

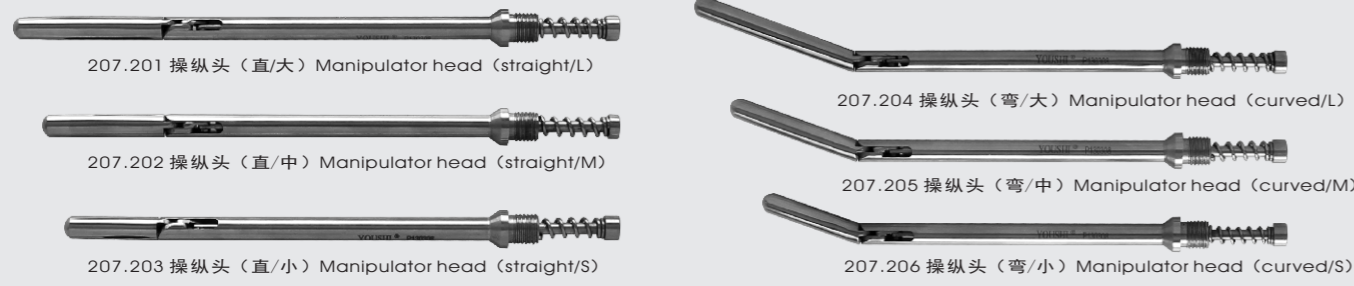

207.201 操纵头 (直/大) Manipulator head (straight/L)

207.202 操纵头 (直/中) Manipulator head (straight/M)

207.203 操纵头 (直/小) Manipulator head (straight/S)

207.204 操纵头 (弯/大) Manipulator head (curved/L)

207.205 操纵头 (弯/中) Manipulator head (curved/M)

207.206 操纵头 (弯/小) Manipulator head (curved/S)

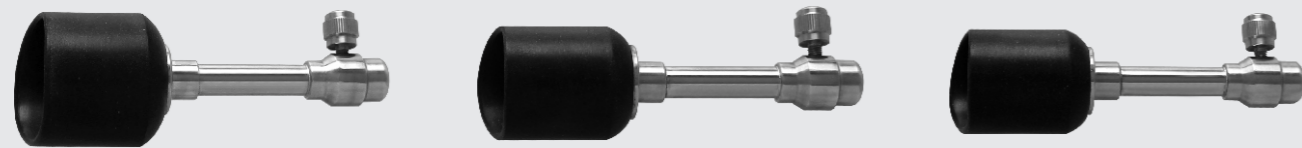

207.207 举宫杯 (大) Apparatus (L)

207.208 举宫杯 (中) Apparatus (M)

207.209 举宫杯 (小) Apparatus (S)

YS206 JGQ型举宫器 Uterus apparatus

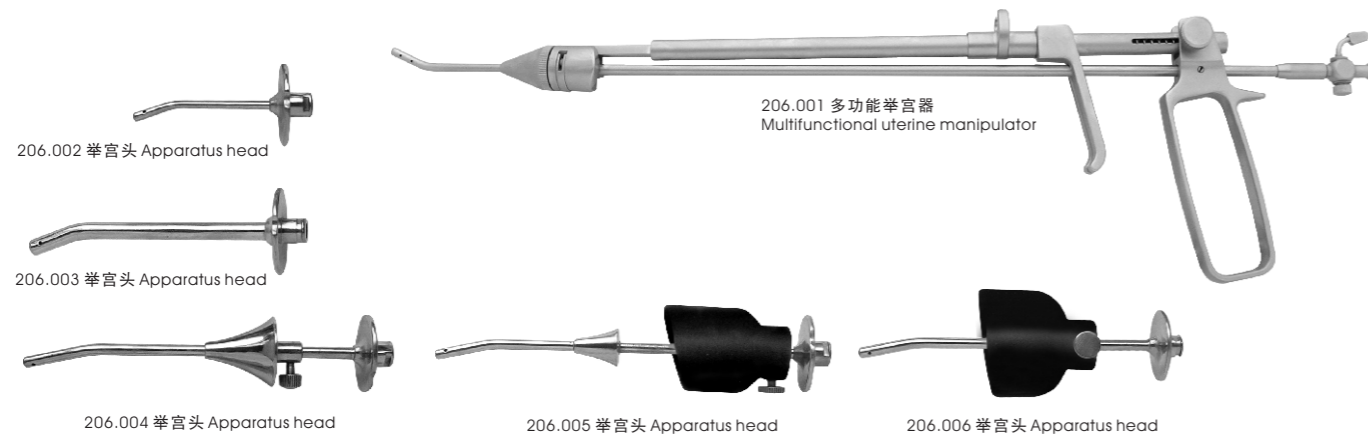

206.001 多功能举宫器  
Multifunctional uterine manipulator

206.002 举宫头 Apparatus head

206.003 举宫头 Apparatus head

206.004 举宫头 Apparatus head

206.005 举宫头 Apparatus head

206.006 举宫头 Apparatus head

YS211 DQJ- I 型电切镜 (宫腔) Hystero resectoscope

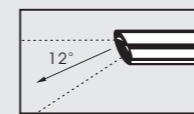
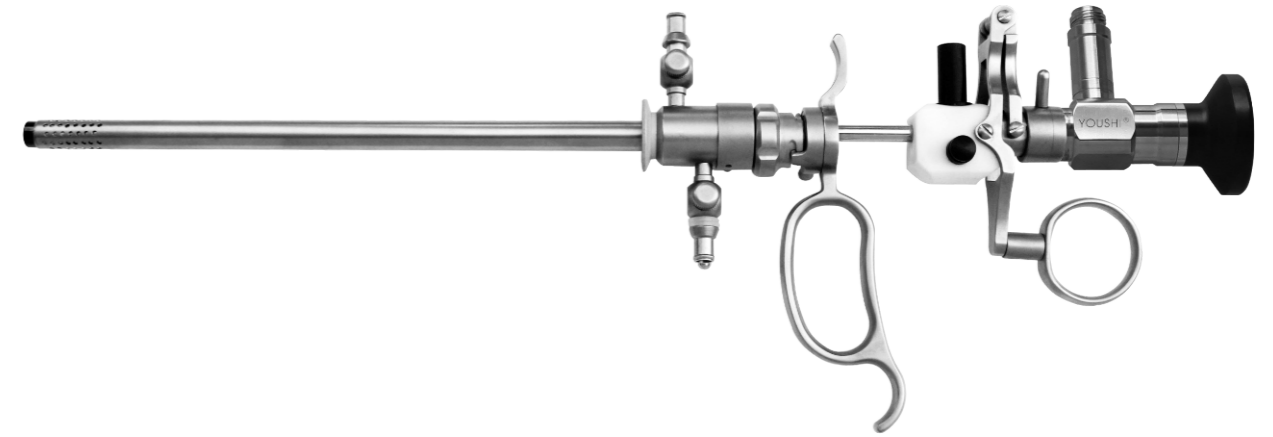

Y20112 12° 宫腔内窥镜 Endoscope  $\Phi 4 \times 302\text{mm}$

504.005 操作器 Working element

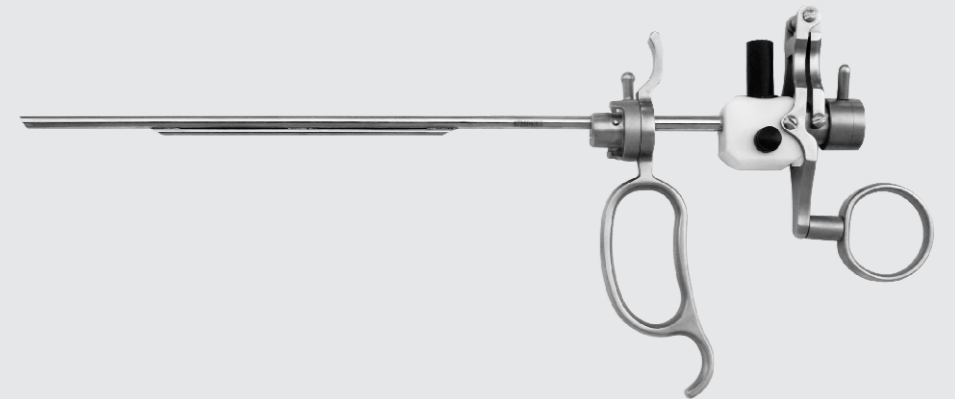

504.001 内鞘 Inner sheath



504.004 外鞘 Outer sheath

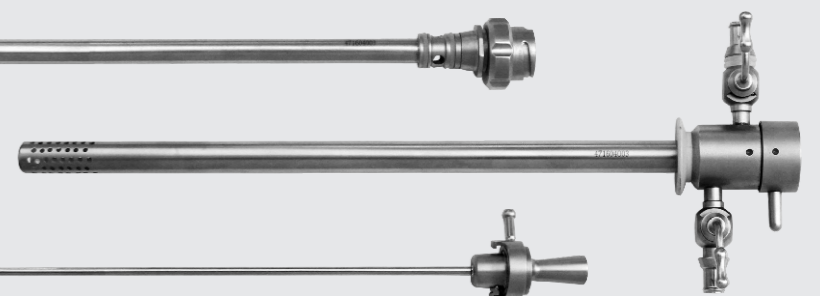

504.002 闭孔器 Obturator

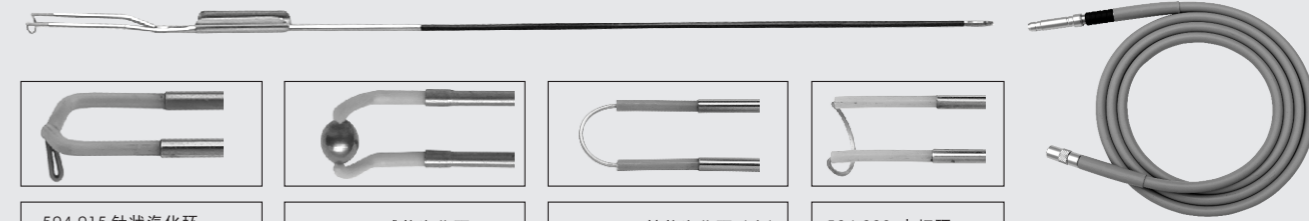

504.015 针状汽化环  
Vaporization electrode  
(needle type)

504.016 球状汽化环  
Vaporization electrode  
(Ball type)

504.008.1 铲状汽化环 (直)  
Vaporization electrode  
(Straight type)

504.009 电切环  
Cutting loop

111.009 导光束 Light guide cable

YS209A ZZ型阴式子宫诊疗成套手术器械 Instruments for Hysterectomy surgery



209.001 阴道压板  
Vaginal Depressor

209.002 宫颈压板  
Cervical Depressor

209.003 肌瘤剥离器  
Myoma stripping

201.025 宫腔取石钳  
Biopsy forcep

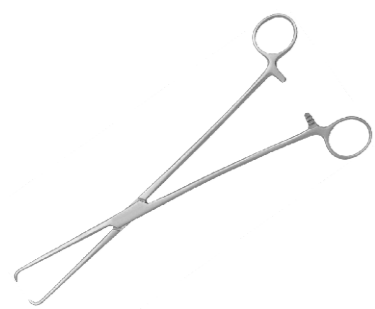

209.005 单爪肌瘤抓钳  
Single Grasping forceps

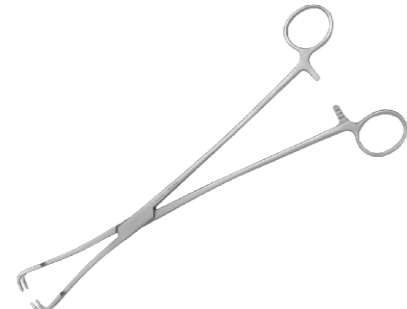

209.004 双爪肌瘤抓钳  
Double Grasping forceps

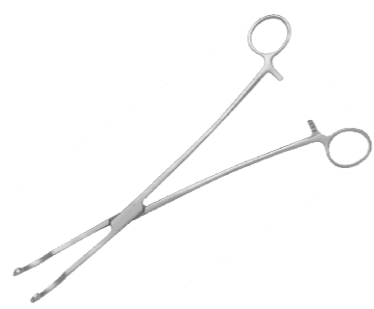

209.006 固有韧带钩形钳  
Ligament hook-shape forceps

YS209B ZZ型阴式子宫诊疗成套手术器械（专用阴道拉钩） Instruments for Hysterectomy surgery



209.006 固有韧带钩形钳 Hemostat  
(C-shaped head)

209.017 弯头止血钳  
Hemostat (Curved)

209.018 直头止血钳  
Hemostat (Straight)

YS209C ZZ型阴式子宫诊疗成套手术器械（专用阴道缝合拉钩） Instruments for Hysterectomy surgery

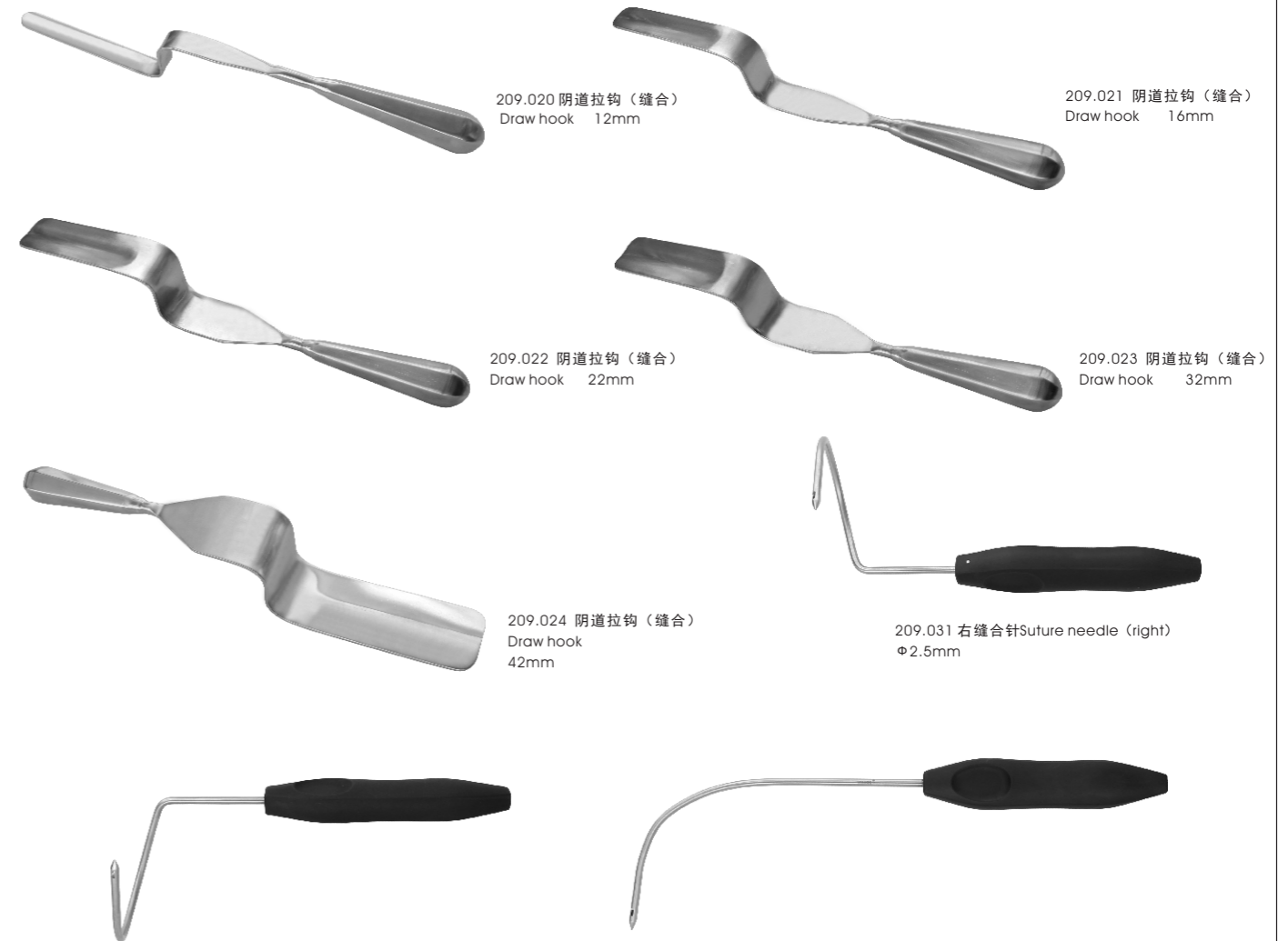

209.020 阴道拉钩（缝合）  
Draw hook 12mm

209.021 阴道拉钩（缝合）  
Draw hook 16mm

209.022 阴道拉钩（缝合）  
Draw hook 22mm

209.023 阴道拉钩（缝合）  
Draw hook 32mm

209.024 阴道拉钩（缝合）  
Draw hook 42mm

209.031 右缝合针 Suture needle (right)  
Φ2.5mm

209.032 左缝合针 Suture needle (left)  
Φ2.5mm

209.030 缝合针 Suture needle  
Φ2.5mm

YS209B ZZ型阴式子宫诊疗成套手术器械（专用阴道拉钩） Instruments for Hysterectomy surgery

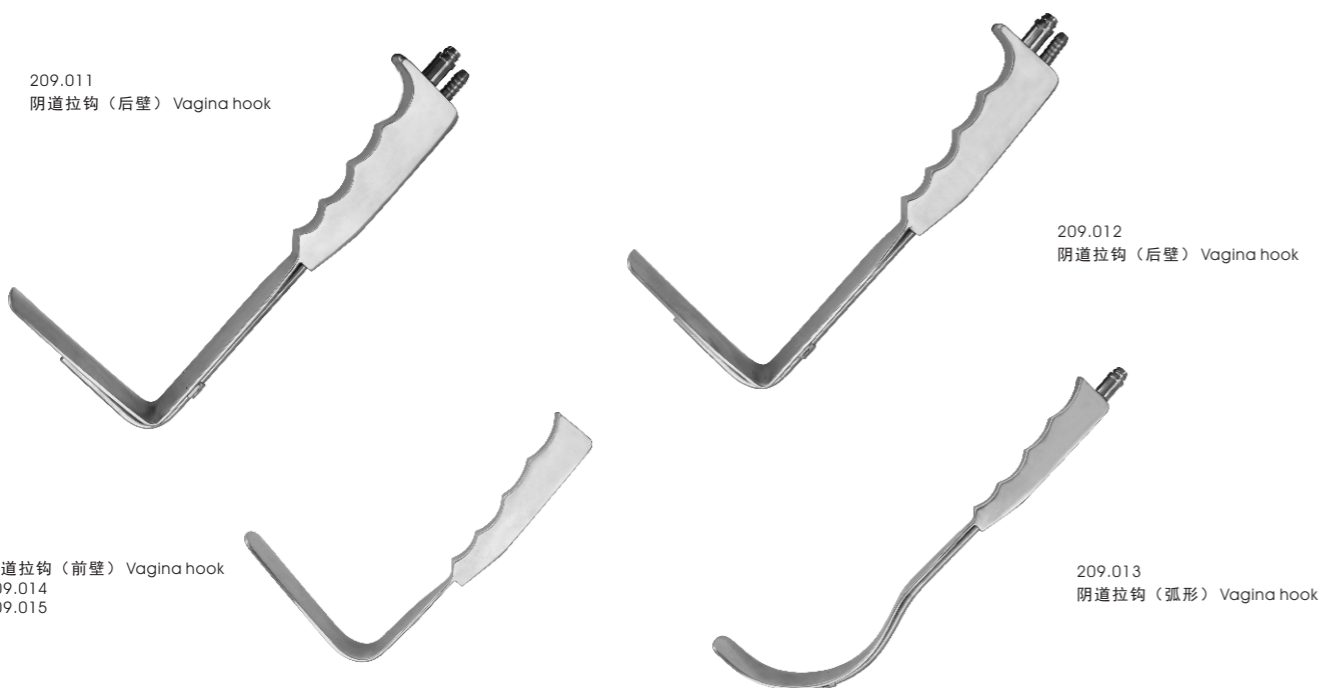

209.011 阴道拉钩（后壁）  
Vagina hook

209.012 阴道拉钩（后壁）  
Vagina hook

阴道拉钩（前壁）  
Vagina hook  
209.014  
209.015

209.013 阴道拉钩（弧形）  
Vagina hook



内窥镜 Endoscope

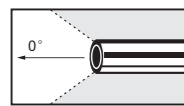

Y5030 内窥镜 Endoscope  
0° φ4X302mm

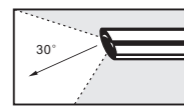

Y5033 内窥镜 Endoscope  
30° φ4X302mm

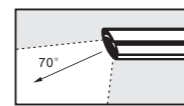

Y5037 内窥镜 Endoscope  
70° φ4X302mm

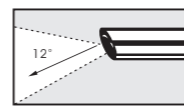

Y50312 内窥镜 Endoscope  
12° φ4X302mm

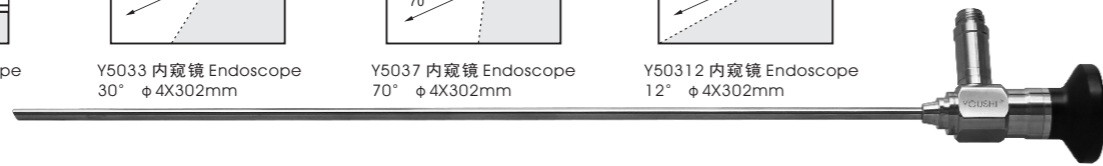

YS501 膀胱碎石镜 Lithotripsy

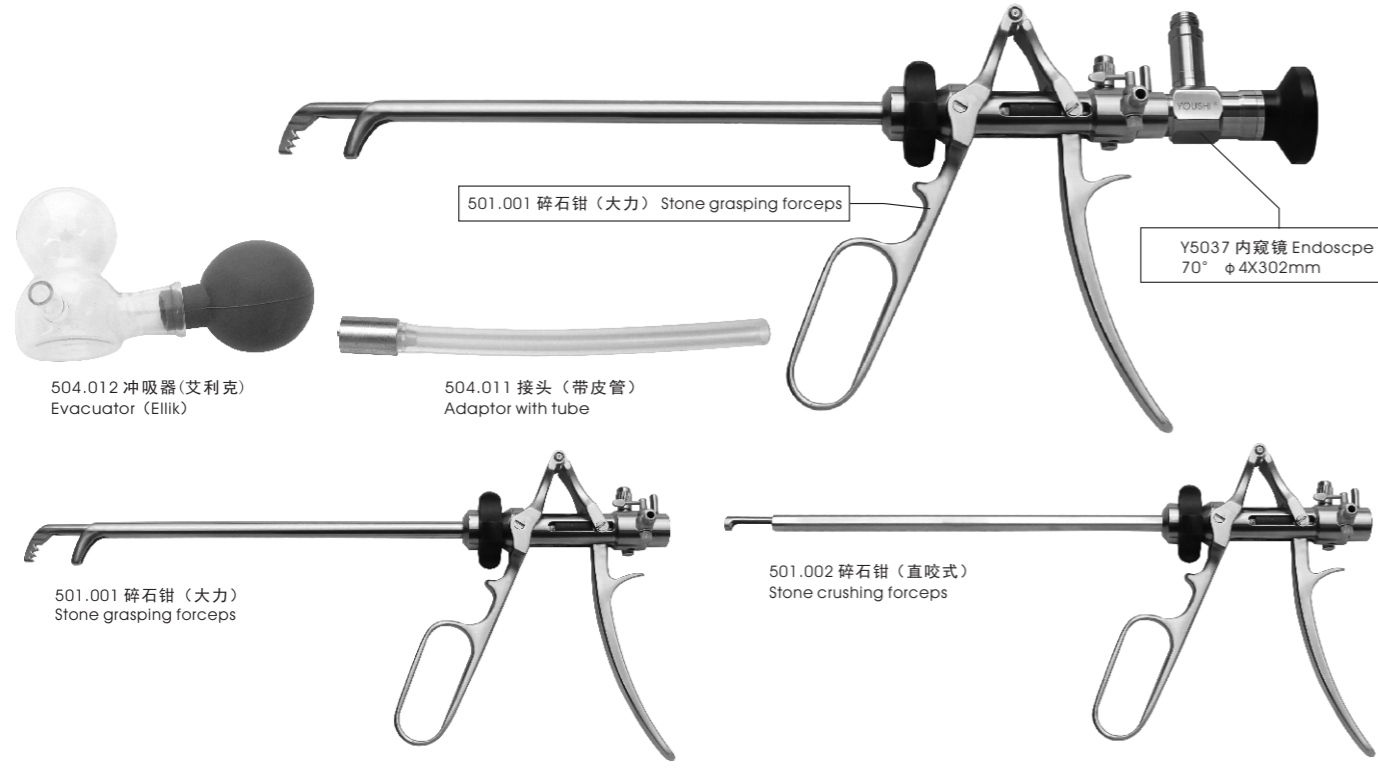

501.001 碎石钳 (大力) Stone grasping forceps

Y5037 内窥镜 Endoscope  
70° φ4X302mm

504.012 冲吸器 (艾利克) Evacuator (Ellik)

504.011 接头 (带皮管) Adaptor with tube

501.001 碎石钳 (大力) Stone grasping forceps

501.002 碎石钳 (直咬式) Stone crushing forceps

YS508 输尿管肾镜 Ureterorenoscopy set

Y50812 输尿管肾镜 Ureterorenoscopy set 12°

- 508.001 操作器 Manipulator
- 508.002 扩张器 Dilator 13Fr
- 508.003 扩张器 Dilator 11Fr
- 508.004 扩张器 Dilator 9Fr
- 508.005 金属导丝 Metal wire
- 508.006 软性齿抱钳 (硬管) Grasping forceps
- 508.007 软性活检钳 (硬管) Biopsy forceps
- 508.008 软性剪刀 (硬管) Flexible Grasping forceps
- 508.009 软性异物钳 (硬管) Flexible Biopsy forceps
- 503.012 水阀连接器 Adaptor
- 503.016 密封帽 Sealed cap
- 111.010 导光束 Light transmitting bundle
- 508.012 套石篮 Stone basket (选购件)

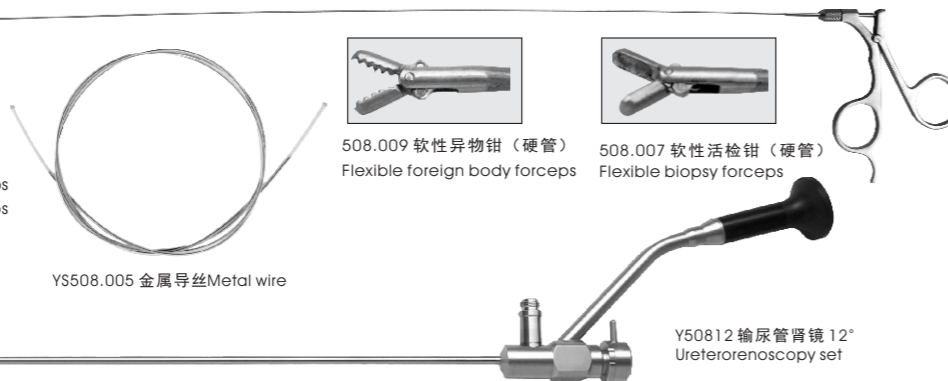

YS508.005 金属导丝 Metal wire

Y50812 输尿管肾镜 12° Ureterorenoscopy set

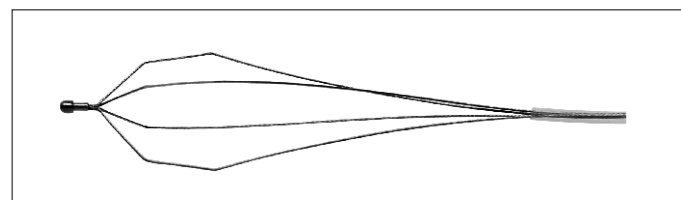

508.012 套石篮 Stone basket

Ys503 NPJ- I 型尿道膀胱镜及配套手术器械 Cystoscope (Lockable)

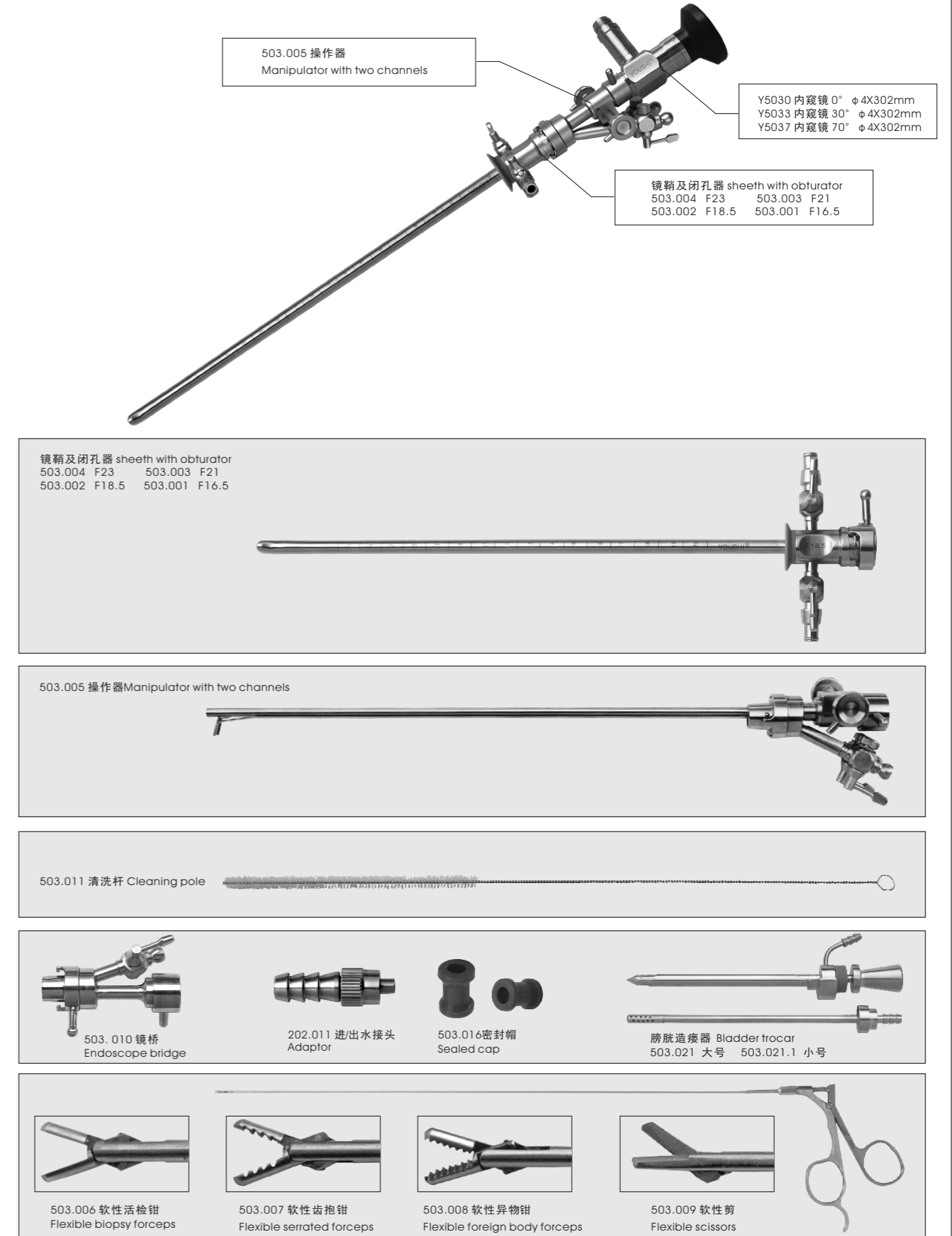

503.005 操作器 Manipulator with two channels

Y5030 内窥镜 0° φ4X302mm  
Y5033 内窥镜 30° φ4X302mm  
Y5037 内窥镜 70° φ4X302mm

镜鞘及闭孔器 sheath with obturator  
503.004 F23 503.003 F21  
503.002 F18.5 503.001 F16.5

镜鞘及闭孔器 sheath with obturator  
503.004 F23 503.003 F21  
503.002 F18.5 503.001 F16.5

503.005 操作器 Manipulator with two channels

503.011 清洗杆 Cleaning pole

503.010 镜桥 Endoscope bridge

202.011 进/出水接头 Adaptor

503.016 密封帽 Sealed cap

膀胱造瘘器 Bladder trocar  
503.021 大号 503.021.1 小号

503.006 软性活检钳 Flexible biopsy forceps

503.007 软性齿抱钳 Flexible serrated forceps

503.008 软性异物钳 Flexible foreign body forceps

503.009 软性剪 Flexible scissors

YS504 DQJ-I 型电切镜 Vaporization resectoscope

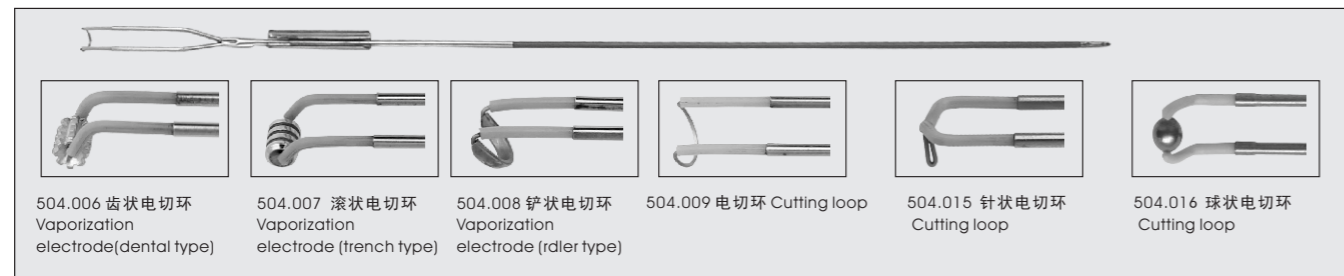
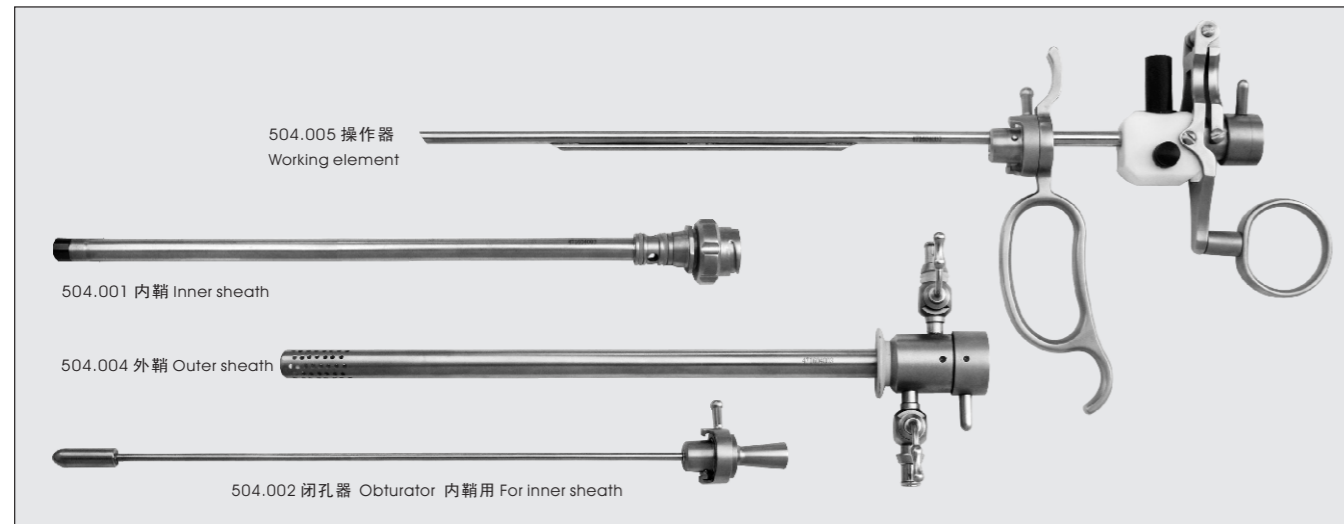
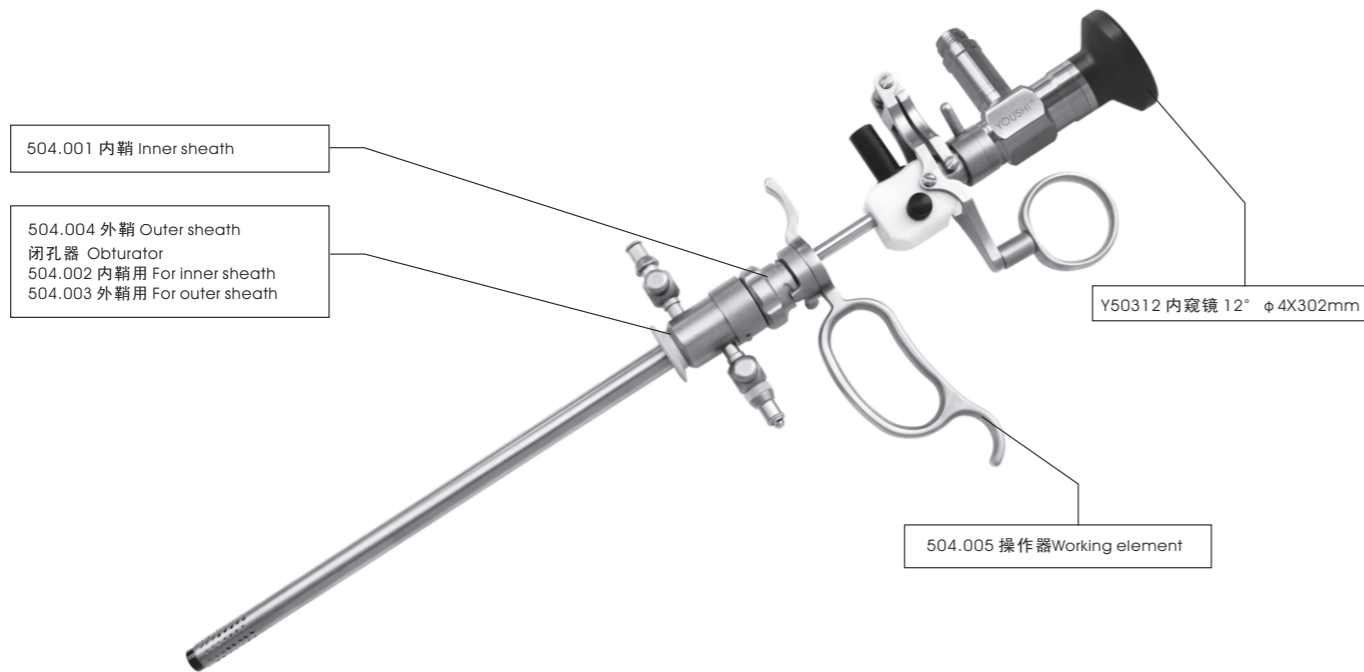

YS507 尿道切开器 (锁口式) Urethrotomy set (Lockable)

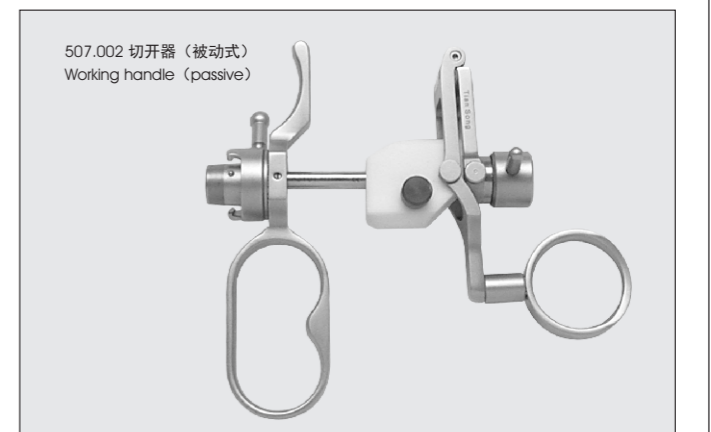
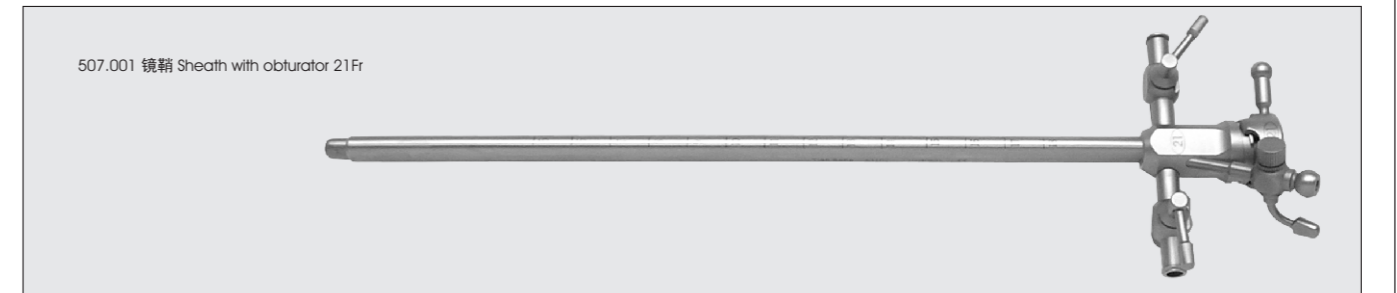
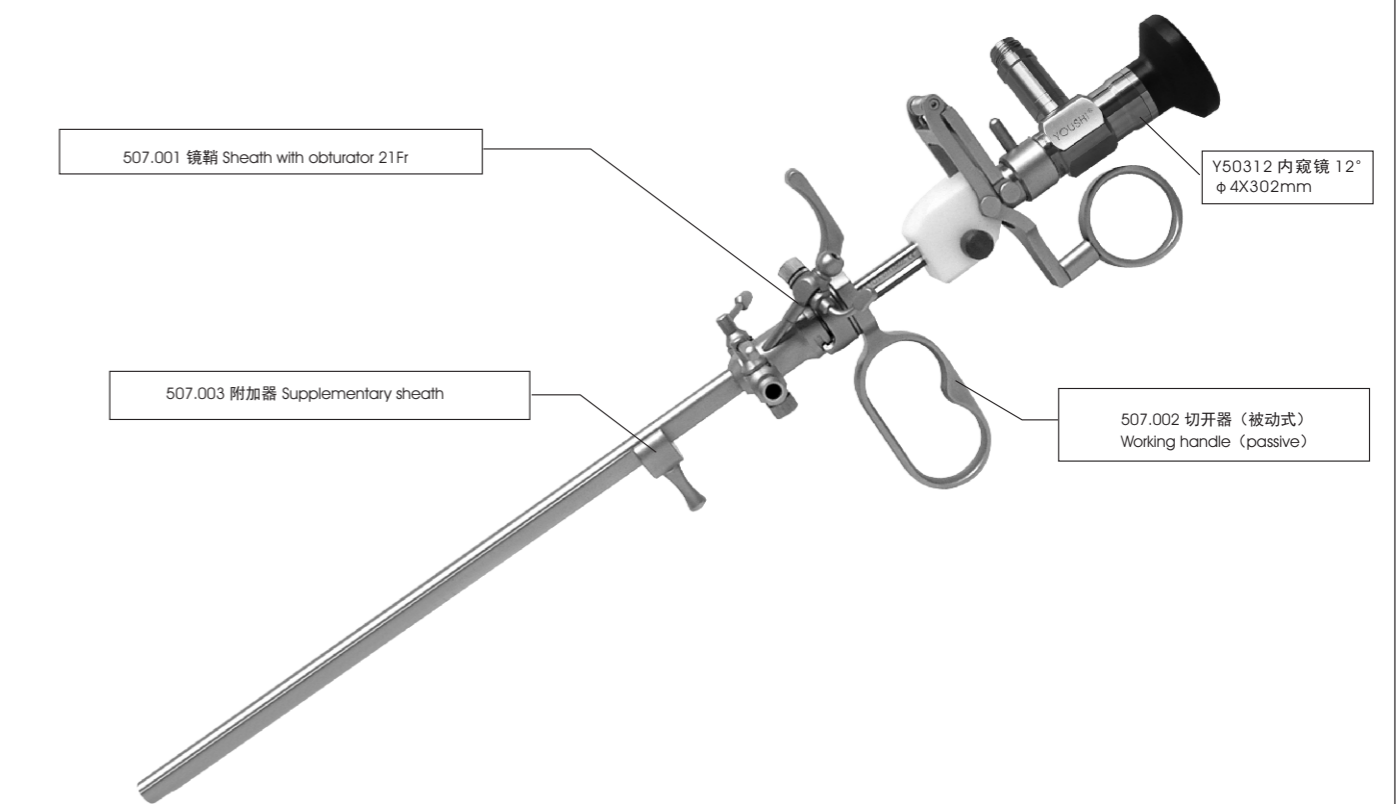

内窥镜 Endoscope

**ENJ型**

耳内窥镜 OTOSCOPE Y3050 0° Φ4 X50mm Y3053 30° Φ4 X50mm	耳内窥镜 OTOSCOPE Y3050.27 0° Φ2.7 X100mm Y3053.27 30° Φ2.7 X100mm
--	--

**BD型**

鼻窦镜 Sinoscope Y3010 0° Φ4 X 175mm Y3013 30° Φ4 X 175mm Y3017 70° Φ4 X 175mm	鼻窦镜 Sinoscope Y3010.27 0° Φ2.7 X 175mm Y3013.27 30° Φ2.7 X 175mm
--	--

**HNJ型**

喉内窥镜 Laryngoscope Y3037 70° Φ8 X 178mm Y3039 90° Φ8 X 178mm	喉内窥镜 Laryngoscope Y3037.6 70° Φ6 X 178mm
---	---

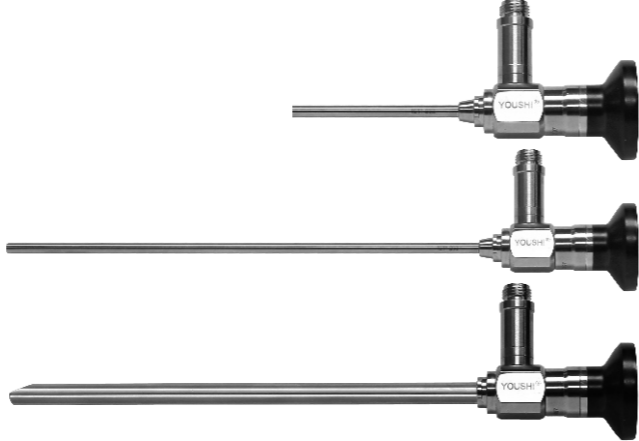

YS305 ERK型耳科手术器械包 Ear Surgical instruments set

305.001 1 305.001.1	305.001 2 305.001.2	305.001 3 305.001.3	305.001 4 305.001.4	305.001 5 305.001.5	305.001 6 305.001.6	305.001 7 305.001.7	305.001 8 305.001.8	305.001 9 305.001.9	305.001 10 305.001.10	305.001 11 305.001.11
---------------------	---------------------	---------------------	---------------------	---------------------	---------------------	---------------------	---------------------	---------------------	-----------------------	-----------------------

305.002 中耳剪 Middle ear forceps

305.003 中耳息肉钳 short triticeons forceps

305.004 上弯耳钳 upward forceps

305.005 耳钳 Forceps

305.006 耳钳(镫骨安装钳) Fixed stapes forceps

305.007 耳钳(镫骨头钳) stapes head forceps

305.008 五官科吸引管 (直形) Suction for Ear operating (Straight)

305.009 五官科吸引管 (弯形) Suction for Ear operating (Curved)

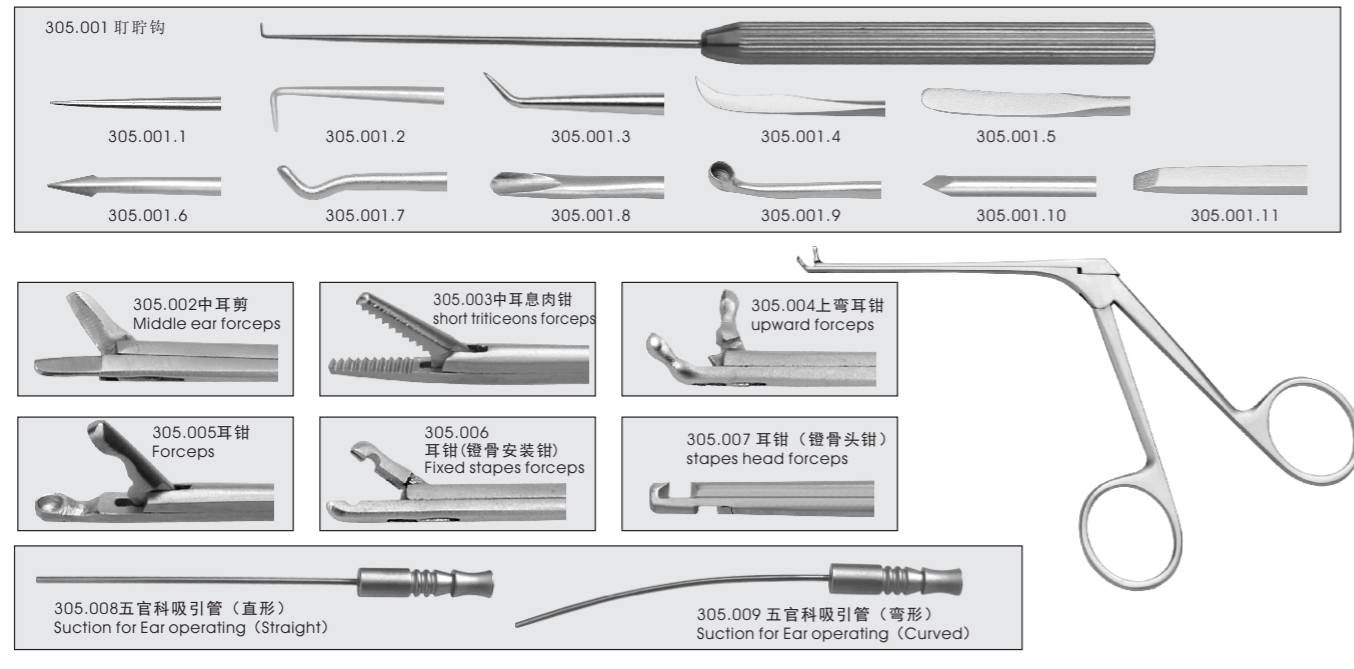

YS308 耳用刨削器 (耳电钻) Otoscope cutting aspirator

308.001 控制器 Current Controller

308.002 手机马达 Mainframe

308.003 脚控开关 Down Controller

308.004 直机头 Machine Head (Straight)

308.005 弯机头 Machine Head (Curved)

308.006 耳钻头 Ears with bits 球形 Φ2×70

308.007 耳钻头 Ears with bits 球形 Φ3×70

308.008 耳钻头 Ears with bits 球形 Φ4×70

308.009 耳钻头 Ears with bits 球形 Φ5×70

308.010 耳钻头 Ears with bits 球形 Φ6×70



YS306 鼻窦刨削器 (鼻电钻) Uptodate oesophagoscope

306.002 控制器 Current Controller

306.003 脚控开关 Down Controller

306.001 手机马达 Mainframe

306.006 斜切口刀头 Tool

306.007 斜口齿刀头 Tool

306.008 球状形刀头 Tool

306.009 内外齿刀头 Tool 选购件

306.010 内切弯刀头 Tool

306.011 外切弯刀头 Tool

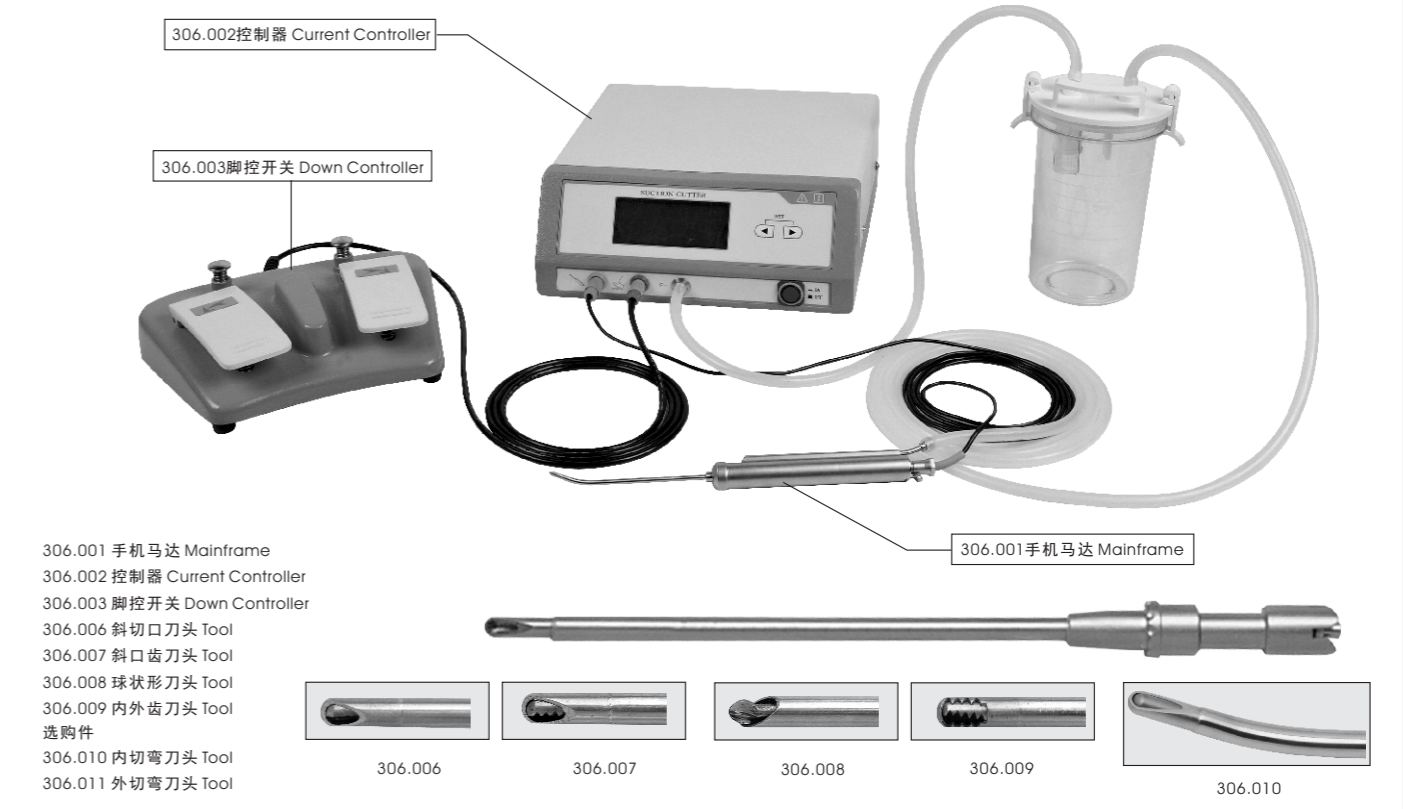

YS401 食道镜 Esophagoscope

食道镜 Esophagoscope

401.001 Φ9X13 X 250mm

401.002 Φ11X15 X 300mm

401.003 Φ10X16 X 360mm

401.004 Φ13X17 X 380mm

401.005 Φ12X18 X 400mm

吸引管 Suction tubea

401.010 Φ2.5mm X 450mm

401.011 Φ3mm X 450mm

401.012 Φ4mm X 450mm

401.013 食道镜手柄 Esophagoscope -handle

食道异物钳 Foreign body forceps

401.006 鸭口形 Duck mouth type Φ4 X 500mm

401.007 鸭口形 Duck mouth type Φ4 X 350mm

食道异物钳 Foreign body forceps

401.008 倒齿形 Pawl type Φ4mm X 500mm

401.009 倒齿形 Pawl type Φ4mm X 350mm

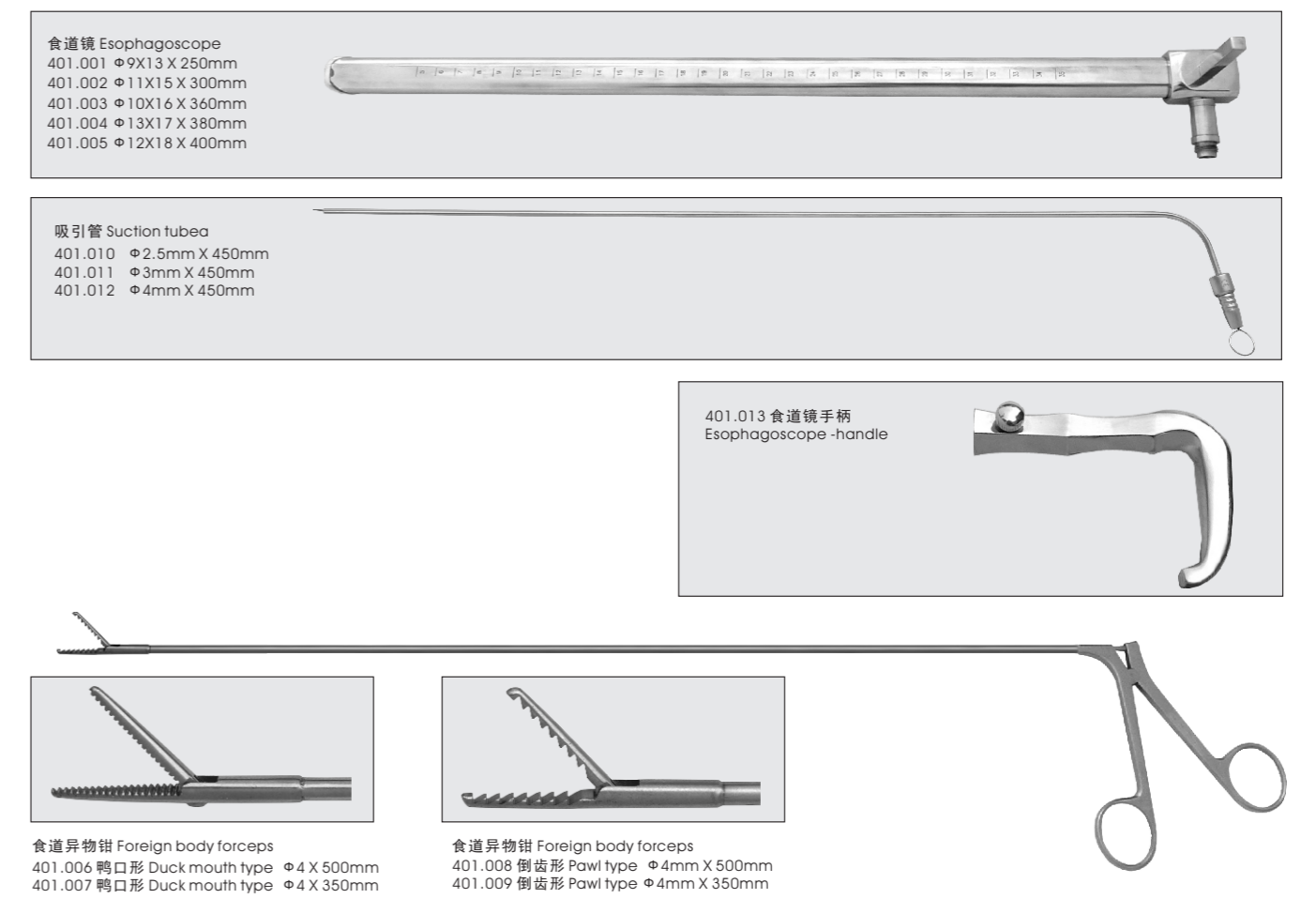

YS301 BD型鼻窦镜成套手术器械 Sinoscope set

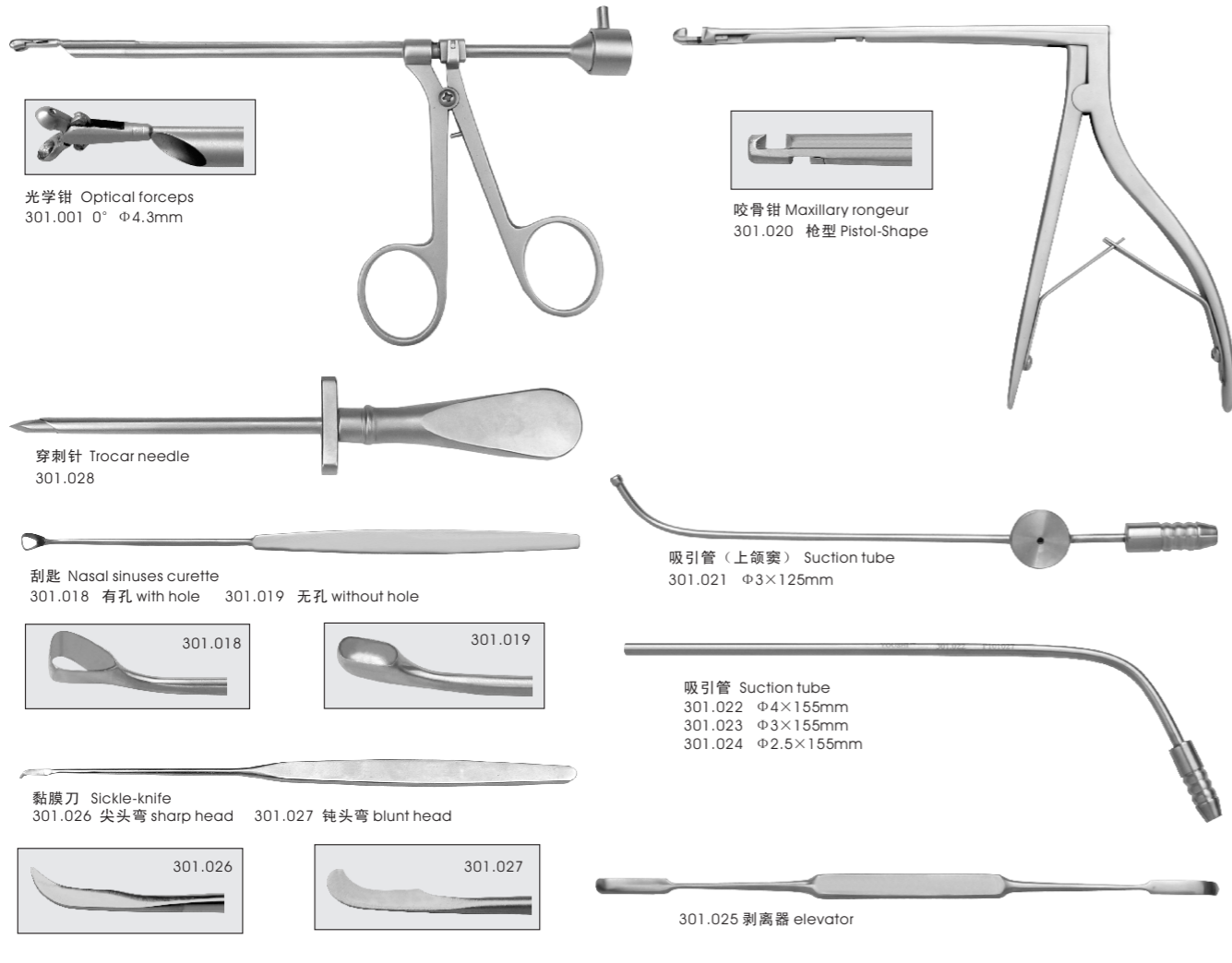

YS301 BD型鼻窦镜成套手术器械 Sinoscope set

息肉钳 (尖圆)  
Tissue forceps of nasal cavity  
301.007 0° 105mm  
301.008 30° 105mm  
301.009 45° 105mm  
301.010 90° 105mm  
301.017 45° 带吸引管  
with suction tube

息肉钳 (长圆)  
Polyp forceps of nasal cavity  
301.011 105mm  
异物钳  
Nasal foreign body forceps  
301.016 105mm

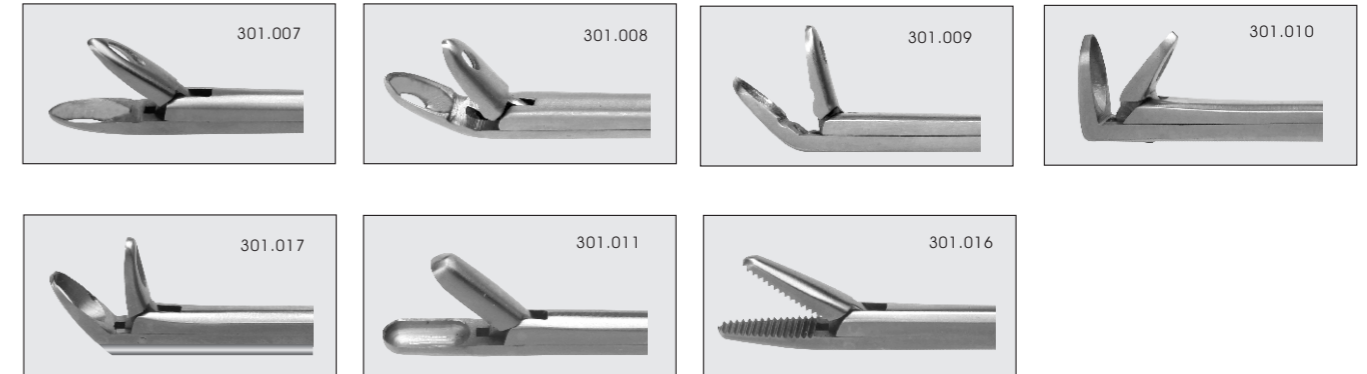

活检钳  
Nasal sinuses forceps  
301.012 100° 左右开口  
Open to left or right  
301.013 70° 左右开口  
Open to left or right  
301.014 70° 前后开口  
Open to ahead and back  
301.015 上下开口  
Open to up and down

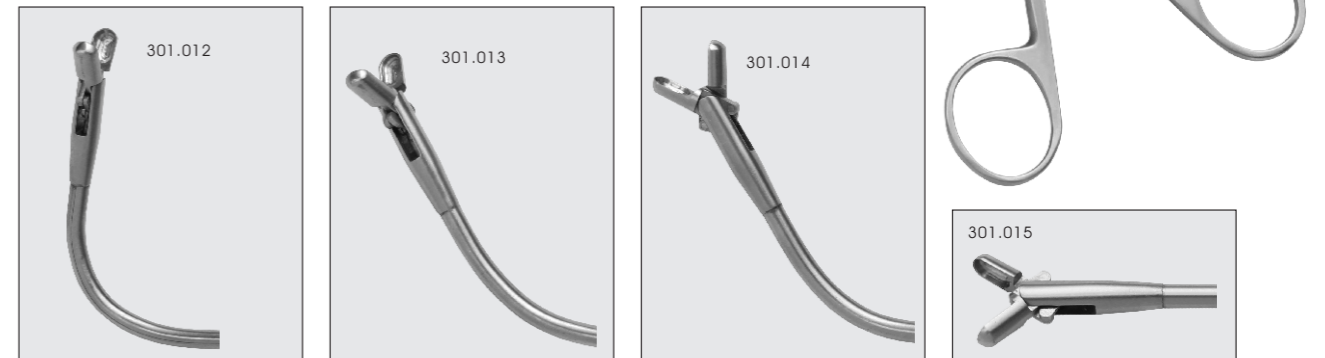

可拆卸钳、剪

拆卸图

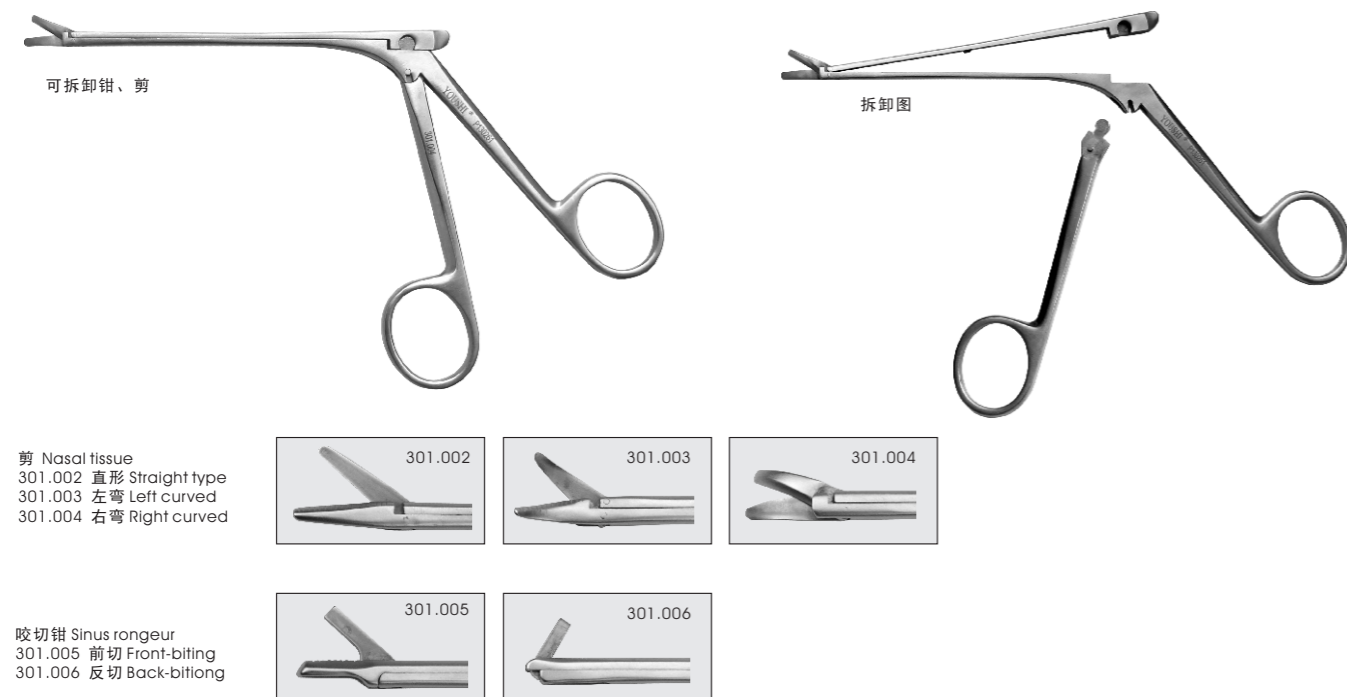

YS303 ZC型支撑喉镜 Self-retaining laryngoscopy set

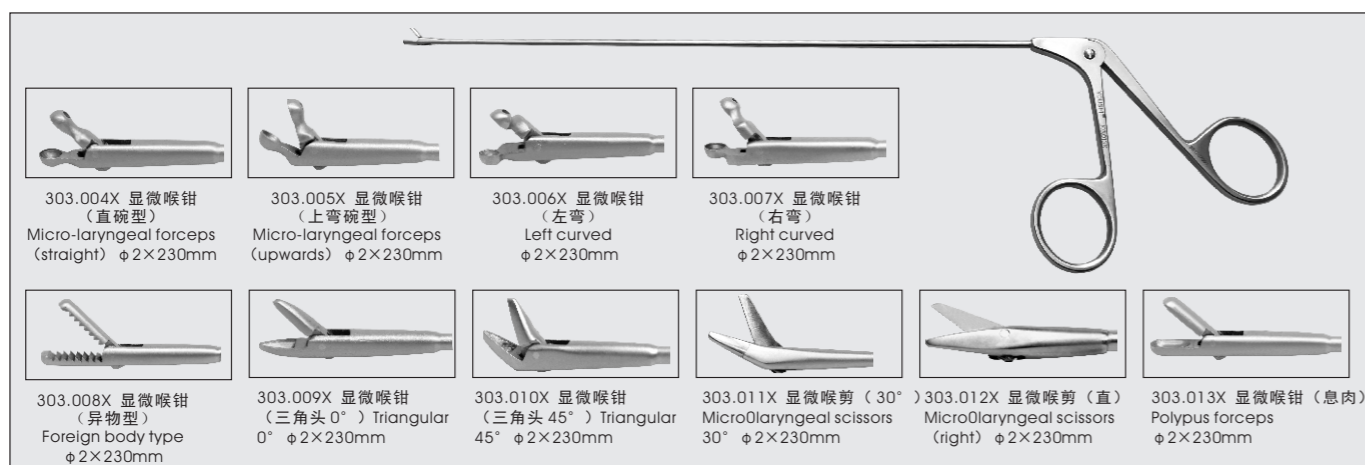
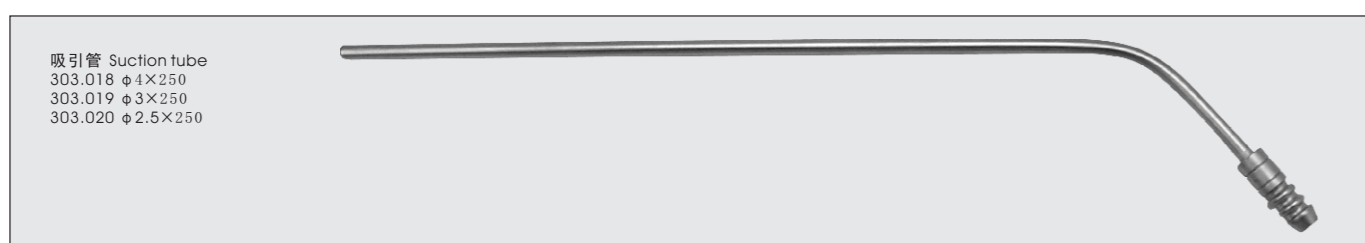
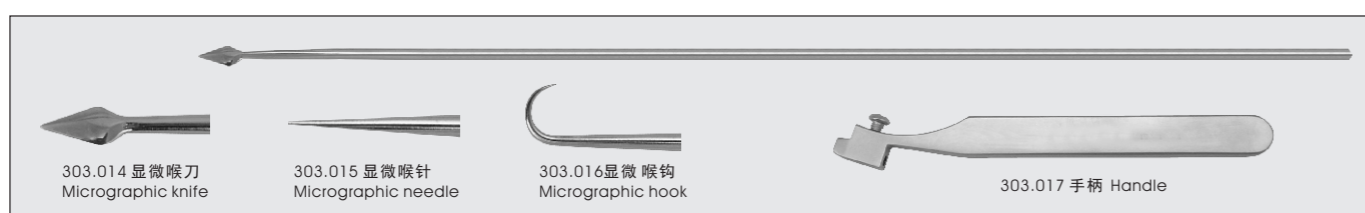
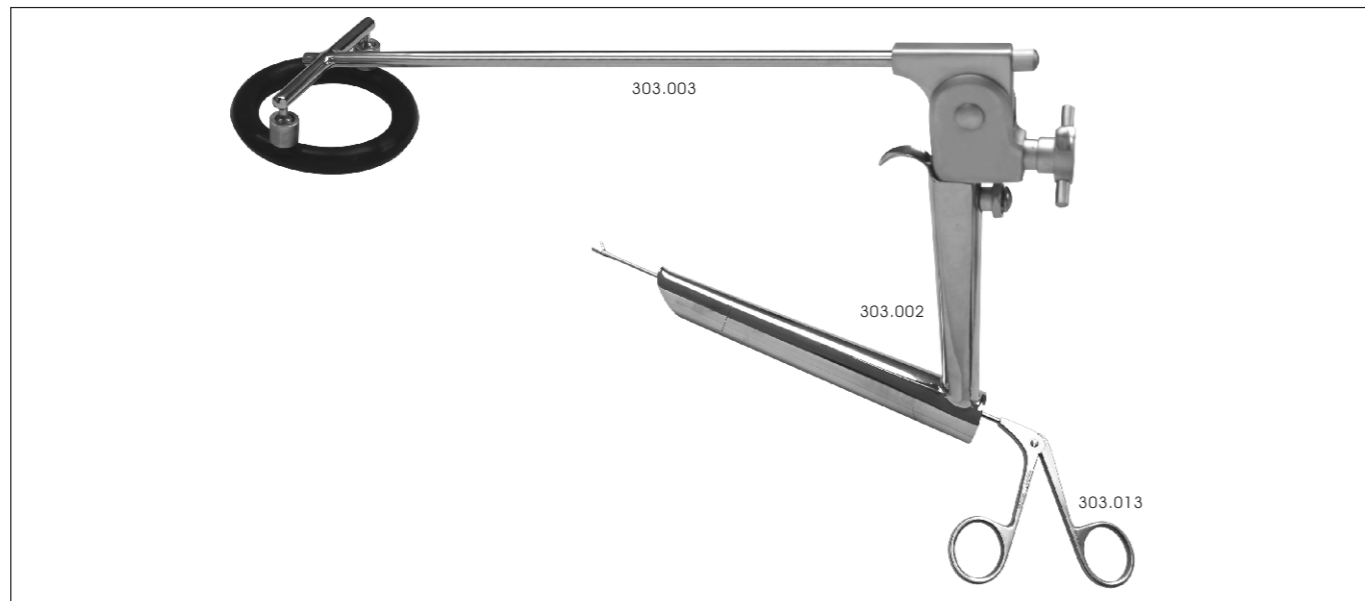

YS601 关节镜手术器械 Arthroscopy set

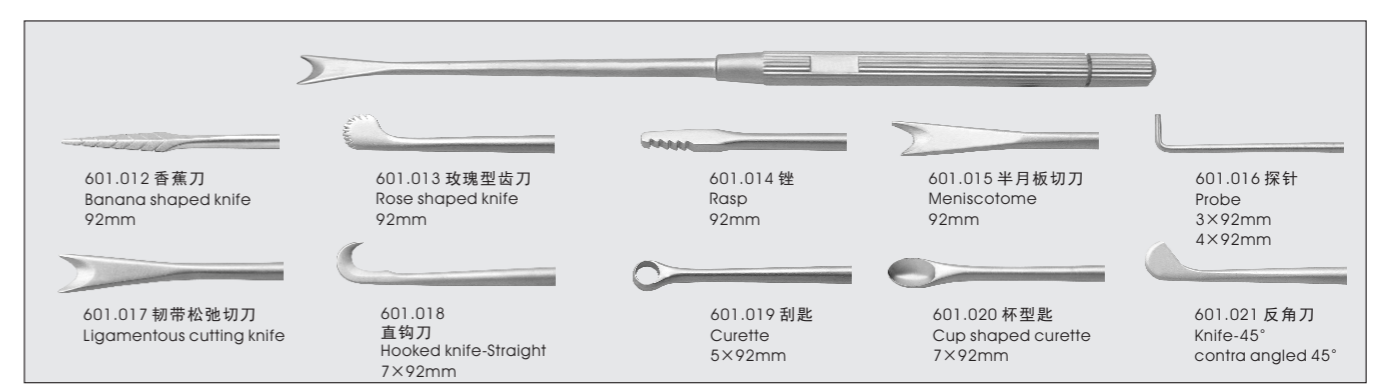
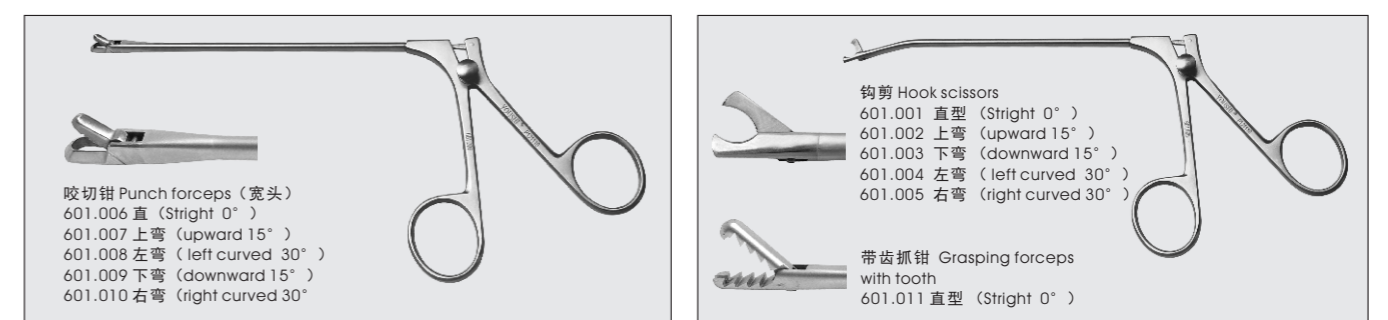
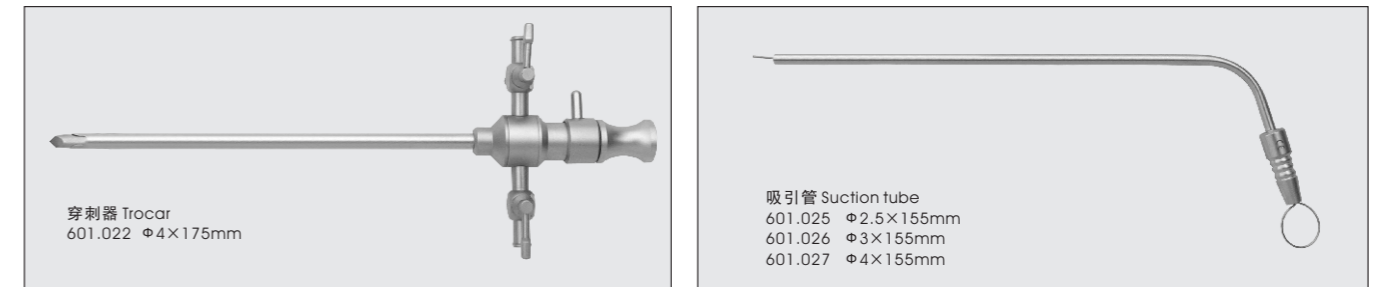
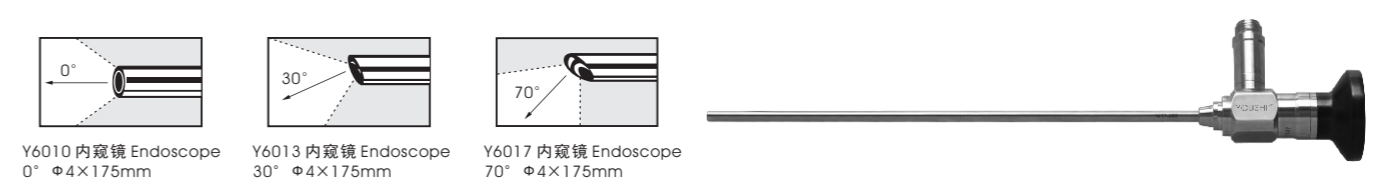

YS602 关节刨削器 Arthroscope electric-drill

- 602.101 主机 (控制器) Current Controller
- 602.102 脚踏控制器 Down Controller
- 602.103 关节刨削器手机 Mainframe
- 602.104 关节刀头 斜口有齿 Tool
- 602.105 关节刀头 斜口无齿 Tool
- 602.106 关节刀头 内外有齿 Tool
- 602.107 关节刀头 球状 Tool



摄像、显像系统设备 Camera, Endoscope display system

111.020 YS-198型 1CC  
111.021 YS-398型 3CC  
111.022 YS-398HD型 3CC 高清

111.026 监视器 Monitor

内窥镜 Endoscope

111.030 111.031  
光学接口 Optics-port

111.004 YSG-1 型  
医用内窥镜冷光源  
Cold light source

111.006.1 YSJ-1 型  
医用加压器 (蠕动泵)  
Suction irrigation device

111.009 导光束  
Light guide cable

111.051 医疗仪器专用车 Medical Trolley

其他附属设备 Other

111.006.3 YSJ-III 型医用加压器 (冲吸泵)  
Suction Irrigation appliance

111.003 高频电刀  
High frequency electric-cutter

111.001 20升/分钟 20L/minute 111.002 30升/分钟 30L/minute  
气腹机 Insufflator

111.008 模拟操作箱 Analog operation box  
腹腔镜 模拟训练箱

111.007 器械清洗泵 Cleaning device for instruments

导光束 Light guide cable

内窥镜连接器 Adaptor for endoscope

111.009 普通螺口 Common / worm type  $\phi 4 \times 1800\text{mm}$   
111.009.1 普通插口 Common / insert type  $\phi 4 \times 1800\text{mm}$   
111.010 普通螺口 Common / worm type  $\phi 4 \times 2500\text{mm}$   
111.010.1 普通插口 Common / insert type  $\phi 4 \times 2500\text{mm}$

ACMI  
WOLF  
STORZ  
OLYMPUS

WOLF

ACMI

STORZ  
OLYMPUS

WOLF

OLYMPUS  
ACMI

111.040 连接器  
配WOLF内窥镜  
Adaptor for WOLF  
endoscope

111.041 连接器  
配WOLF冷光源  
Adaptor for WOLF  
cold light source

111.042 连接器  
配OLYMPUS冷光源  
Adaptor for OLYMPUS  
cold light source

111.043 连接器  
配ACMI导光束插头端  
Adaptor for ACMI  
light guide cable

111.044 连接器  
配ACMI,STRYKER内窥镜  
Adaptor for ACMI,STRYKER  
endoscope

111.045 连接器  
配STRYKER导光束插头端  
Adaptor for STRYKER  
light guide cable

医用器械灭菌盒 Sterilization case

医用内窥镜灭菌盒 Sterilization case

医用灭菌盒 Sterilization case

111.060 手术器械消毒盒 (耐高温高压)  
111.061 手术器械消毒盒 (包边) (耐高温高压)  
111.062 电动子宫切割器及附件消毒盒 (耐高温高压)

医用内窥镜灭菌盒 Sterilization case

111.070 内窥镜消毒盒 (耐高温高压)  
111.071 内窥镜消毒盒 (耐高温高压)  
111.075 内窥镜包装盒A  
111.076 内窥镜包装盒B  
Endoscope packing box

111.060

111.061

111.062

111.070

111.071